

**GRAN VIA
TECHNICAL REGULATIONS
FIRA DE BARCELONA**



Fira Barcelona



INDEX

1. SAFETY AND EMERGENCY REGULATIONS	7		
1.1 Actions to take in the case of emergency			
1.2 Floorplans and escape routes			
1.3 Permitted capacity			
1.4 Fire prevention. Material specifications			
1.5 Surveillance of exhibition areas and exhibitor goods			
1.6 First aid			
2. OCCUPATIONAL RISK REGULATIONS	13		
2.1 Employee passes during build up and break down			
2.2 Provisions on occupational risk prevention during build up and break down			
2.3 Information on risks and preventative measures			
2.4 Occupational risk prevention for external organizers			
3. REGULATIONS ON THE BUILD UP OF STANDS AND ADAPTATION OF SPACES	17		
3.1 Stand construction and decoration			
3.2 Modular structures			
3.3 Free constructions			
3.4 Construction of complex structures in the halls and outdoors			
3.5 Small tents outdoors			
3.6 Inflatable structures			
3.7 Regulations for suspending aerial structures (rigging)			
3.8. Health and safety at construction sites			
4. REGULATIONS FOR THE BUILD-UP OF PERIMETERED ENCLOSURES OR ROOMS	29		
4.1 General conditions			
4.2 Fire safety			
4.3 Safe use and accessibility			
5. REGULATIONS ON TECHNICAL SERVICES FOR STANDS	35		
5.1 Water and drainage services			
5.2 Compressed air services			
5.3 Installation of air conditioning systems			
5.4 Gas installations and elements that generate combustion or inflammable gases			
5.5 Welding equipment and hot work			
5.6 Installation of antennas and radio signal transmitting and receiving stations			
5.7 Limitations to the build up of stands and adaptation of exhibition spaces			
5.8 Ramps for accessible routes			
5.9 Smoke detectors			
6. INSTALLATIONS AND POWER SUPPLY REGULATIONS	45		
6.1 Power supply			
6.2 Legalization of the installation			
6.3 Electrical connection to service chests or exhibitor boxes			
6.4 Power supply through service lines			
6.5 Electricity distribution of the stands			
6.6 24-hour or permanent switchboard			
6.7 Electrical disconnection			
6.8 General conditions for installing and contracting power supply			
7. CLEANING AND WASTE MANAGEMENT REGULATIONS	51		
7.1 Stand cleaning			
7.2 Waste removal and management			
8. TECHNICAL REGULATIONS FOR SHOW DAYS	55		
8.1 Use of machines and tools during the event			
8.2 Use of projection during the event			
8.3 Maximum noise level permitted			
8.4 Photographic and audiovisual reports			
8.5 Catering			
8.6 Connectivity services			
8.7 Exhibition of vehicles in stands			
8.8 Exhibition of animals in stands			
9. EXTRAORDINARY ACTIVITIES DURING SHOW DAYS	63		
9.1 Creation of “artificial fog” in events and festivities inside the halls			
9.2. Use of drones during the event			
9.3. Other activities			
10. REGULATIONS ON VEHICLE ACCESS IN THE EXHIBITION AREA	65		
10.1 Build up and break down process			
10.2 Access to the exhibition area for loading and unloading activities			
10.3 Arrival and shipment of articles and merchandise			
10.4 Services for empty packaging			
10.5 Arrival of installations and merchandise from abroad (outside the EU)			
10.6 Parking service			
11. TECHNICAL DATA OF HALLS AND EXHIBITION SPACES	71		
11.1. Technical data of the Gran Via exhibition area			
11.2. Plans of the Gran Via exhibition area			
ANNEXES	98		
Annex I: Measures to take in the case of emergency			
Annex II: Occupational risk prevention. Risks and preventative measures			
Annex III: Document of commitment to comply with the current law on food hygiene (Regulation 852/2004)			

SAFETY AND EMERGENCY REGULATIONS

01

SAFETY AND EMERGENCY REGULATIONS

1.1 Actions to take in the case of emergency

During the periods of build up, show days and break down, Fira de Barcelona shall provide general surveillance of the exhibition areas regarding fire safety and other emergencies.

The Fira Barcelona Division of Safety and Mobility is responsible for managing emergencies in accordance with the Emergency Plan that governs the venues, in compliance with the provisions of Decree 30/2015 of March 3rd.

All organizers and exhibitors, as well as their personnel, are subject to the Emergency Actuation Plan. The Fira de Barcelona Division of Safety and Mobility shall provide them with information and guidelines to follow.

Prior to each event and with sufficient notice, Fira de Barcelona shall provide exhibitors and organizers with all relevant information regarding the general emergency and evacuation policies defined for each hall of the exhibition area and adapted to the specific event.

1.2 Floorplans and escape routes

Booth or event floorplans in the exhibition halls must be submitted to Fira de Barcelona within the period previously agreed between the organiser and Fira Barcelona, so that they can be verified and vetted to comply with fire and other emergency safety regulations.

During the build-up and breakdown periods, and for safety reasons, no material or work tools may be placed obstructing the aisles. All materials must remain within the limits of the space of each stand.

In the event that any aisle is effectively obstructed, Fira Barcelona's Cleaning Services may remove the objects. The customer loses the right to claim damages for such removal.

The costs incurred by these actions may be passed onto the exhibitor.

Evacuation Aisles Obstruction

The only obstruction permitted along evacuation corridors and emergency exits are doors or exit discharges. The width of the exit and exit discharge must be at least equal to the width of the exit access, complying with the parameters detailed below. For the remaining corridors or areas adjacent to halls that are not used in their entirety and do not coincide with the hall's evacuation corridors, the use of curtains is permitted.

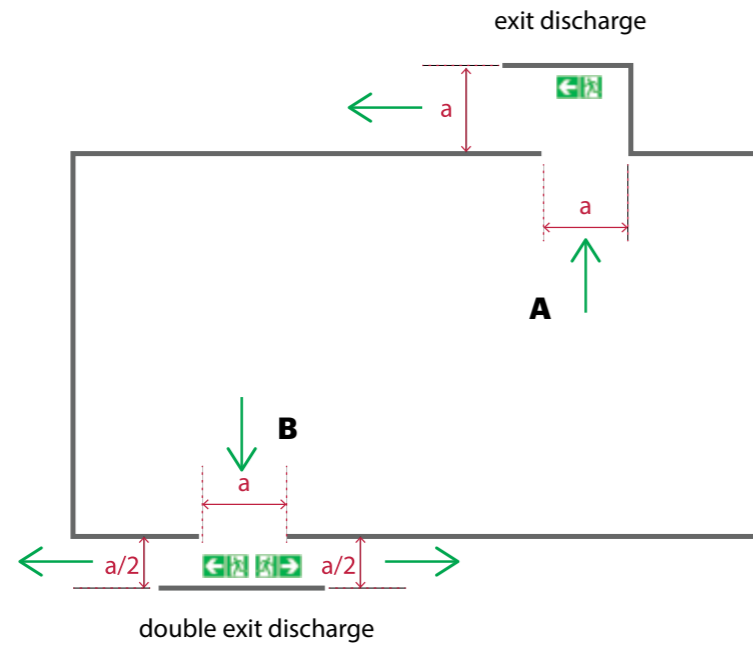

Use of exit discharges in evacuation routes:

- The length of the escape route must not be altered.
- The width of the escape route must be respected.
- If the evacuation is in one direction only (Case A), the width must be equal along the entire route.
- If the escape is two-way (Case B), the width of the exit aisle can be divided by two on each direction.
- The exit discharge must be correctly marked with pictograms approved in accordance with the CTE and must always be visible even in the event of failure of the power supply.

Use of doors along evacuation routes:

- The clear passage width of emergency doors will be equivalent to the clear passage width of the escape corridor in which they are located.
- The width of the door leaf shall not be less than 0.80 m and 2 m in height.
- Doors must open in the direction of evacuation, and use a panic bar according to Regulation UNE EN 1125:2009. Doors that do not have a mechanism and open freely when pushed are permitted. No swing doors are allowed.
- Doors must have a sign indicating "EXIT" (UNE 23034:1988).
- The sign dimensions shall be appropriate for the viewing distance.
- Emergency signs shall always be visible even in the event of the failure of the normal lighting power supply.

Once past the emergency door, the evacuation corridor should maintain its continuity to the hall's exit.

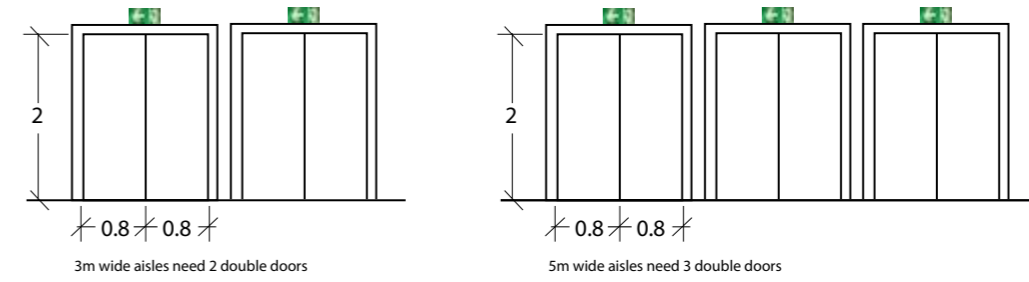

Use of curtains:

- Curtains must have Class 1 fire resistance following UNE-EN 13773:2003.
- The width of the passageway must be completely unobstructed, without any obstacles.
- Curtain support must be self-supporting and ensure structural resistance for permanent and variable actions.
- The curtain shall have a vertical cut-out marked with a photoluminescent strip of at least 100cm, centered in height.
- Emergency signs shall be visible even in case of power failure of the venue.

1.3 Permitted capacity

In general, the available surface of the venue shall be used as criteria for calculating and determining the capacity. The surface is distinguished according to its use, as well as the occupancy levels resulting from the application of the Spanish Technical Building Code, and the Basic Document on Fire Safety.

In the case of using the hall for purposes other than for stand exhibitions, all information related to use, as well as distribution plans, must be provided to the Fira de Barcelona safety services, through the event management team, for approval. The organizer may be required to install additional control elements to correctly manage the capacity in real time, which falls under their responsibility.

1.4 Fire prevention. Material specifications

The materials used for the Fira de Barcelona structures (stands, tents, etc.) must comply with the current regulations. In particular, and with regard to the fire resistance of the material, they must comply with the provisions of the Spanish Technical Building Code (TBC).

Table 4.1 of BD-FS 1. Reaction of surfaces to fire.

- On ceilings and walls: C-s2 and d0.
- Hanging textile elements: Class 1 in accordance with the UNE-EN 13773:2003 standard.

All decorative elements must comply with the same characteristics as the construction elements. They may not incorporate any type of inflammable material, for example straw, wood shavings, paper shavings, dry leaves, etc.

In any case, the Fira de Barcelona technical team reserves the right to request the certificates corresponding to the materials used in the stands or for their decoration.

1.5 Surveillance of exhibition areas and exhibitor goods

During periods of build up, show days and break down, Fira de Barcelona shall be responsible for providing general surveillance, as well as general and preventative safety, with regard to order and fire safety or emergencies of any kind.

Under no circumstances is this security measure intended for and focused on the goods displayed, nor on the particular goods of each exhibitor. Therefore, Fira de Barcelona accepts no liability for the particular goods that are the property of the exhibitors or their employees. Moreover, Fira de Barcelona shall not accept any liability for the robbery or theft of the materials and articles placed in the stands or any other space of the venue, nor for the damages that may be suffered during periods of build up, show days and break down.

Therefore, each exhibitor is exclusively responsible for the surveillance and safety of their particular belongings. However, Fira de Barcelona may provide the necessary support to resolve or process the corresponding complaint with the authorities.

Should an exhibitor wish to have their own surveillance service for their stand, this can be hired through the Fira de Barcelona Sales Department (www.servifira.com).

If, on the contrary, the exhibitor wishes to hire the surveillance service or a security company other than that of Fira de Barcelona, they must provide the "Private surveillance in stands" form, duly completed, to the Division of Safety and Mobility at least 48 hours in advance. This form contains the regulations and conditions for the provision of this service.

1.6 First Aid

During periods of build up, show days and break down, first aid services shall be available, as set forth in Decree 30/2015, of March 3rd.

Fira de Barcelona shall determine the resources needed for this service in order to comply with the said decree and based on the characteristics of each event.

OCCUPATIONAL RISK REGULATIONS

02

OCCUPATIONAL RISK REGULATIONS

2.1 Employee passes during periods of build up and break down

Fira de Barcelona requires the personnel present in the exhibition areas to be duly identified/accredited. To do so, all personnel involved in the build up and break down of the event are given personnel passes.

During the days of build up and break down, individuals under the age of 16 shall not be allowed to enter the halls.

2.1.1. Fira de Barcelona passes for build up and break down

To obtain Fira de Barcelona passes for the build up, the following actions must be carried out:

- Complete the Fira de Barcelona official application form (name, surname, National ID/Passport of the applicant, date of birth and company details).
- Sign the official fact sheet of the occupational risks of Fira de Barcelona.
- Provide employees with official Fira de Barcelona passes, which must have the following mandatory fields:
 - Name
 - Surname
 - National ID/Passport

2.1.2. Organizer passes for build up and break down

The organizer may create passes for the build up and break down. To do so, the following requirements must be met:

- The organizer shall have, at all times, the list of registered employees (name and surname and National ID or passport) and the companies to which they belong.
- The organizer shall provide this list to the labor or police authorities that request it.
- The organizer shall verify the employees with personalized passes in which their name and surname and National ID or passport number appear, or with physically non-transferable systems, such as wristbands.
- At the request of the Fira security personnel, employees must identify themselves with their National ID or passport.

If the organizer cannot fulfill these requirements, the work passes must be created according to the Fira de Barcelona standard procedure.



2.2 Provisions on the prevention of occupational risks during build up and break down

The build up contractors must comply with and ensure that there is compliance (of their contractors and subcontractors) with the current legislation with regard to the prevention of occupational risks that can be applied to the tasks carried out in each case. This is relevant to tasks carried out directly, as well as those that are subcontracted.

The companies that participate in build up and break down tasks must have an Occupational Risk Prevention management system (in accordance with the provisions of the Law on Occupational Risk Prevention 31/95, Art. 30). This section is included in ANNEX No. II of Occupational Risk Prevention.

The build up contractors hired by the exhibitors and companies involved in the build up and break down of stands must immediately report the occurrence of any accident or incident that requires action by Fira de Barcelona to the hall manager, the medical area or Fira de Barcelona personnel.

2.3 Information on risks and preventative measures

ANNEX II contains detailed information about the risks and preventative measures to be considered during the periods of exhibitions and the events build up, as well as the risks and preventative measures to be considered during the show days.

2.4 Prevention of occupational risks for external organizers

The organizer must comply with and ensure their exhibitors (if they have them) comply with the Emergency Plan of the exhibition areas, as well as the current Regulations on Build up, Safety and Electrical Installations.

The space rental contracts that the organizer provides to its exhibitors shall include the said regulations, wherein the form must contain the acknowledgment and acceptance of each exhibitor. For that purpose, Fira de Barcelona shall inform the organizer of any change that occurs with regard to the aforementioned regulations.

The organizer must comply with the provisions and safety regulations of Fira de Barcelona, as well as understand and comply with other relevant legal or conventional regulations in effect with regard to occupational health and safety. The organizer is solely responsible for its implementation and for the consequences resulting from non-compliance.

As a means of coordination, the organizer shall designate a coordinator of preventative activities during the build up and break down tasks of the events or exhibitions that it organizes.

2.4.1. Coordinator of preventative activities

The coordinator of preventative activities shall have the following responsibilities:

- Encourage compliance with the objectives set forth in Article 3 of RD 171/2004.
- Serve as a channel for information that must be exchanged between companies that coincide at the work center.

The coordinator of preventative activities shall have the power to carry out the duties set out in Art. 14 of RD 171/2004.

03

REGULATIONS ON THE BUILD UP OF STANDS AND OCCUPATION OF SPACES

3.1 Stand Construction and Decoration

The contracted space solely includes the surface thereof (being understood as solely the floor and its perimeter). However, specific events include the corresponding stand assembly in the price established per m². This circumstance shall be expressly indicated in the participation regulations of the event, which shall indicate any other circumstance that may be linked to the event.

Therefore, exhibitors must proceed to decorate this surface according to their needs.

In events organized by Fira de Barcelona, the construction of a stand on the rented exhibition surface is a basic requirement. Fira de Barcelona has the power to require compliance with this requirement for those people/companies that have not arranged for the provision of a stand.

Under no circumstances may the adjacent walls of another exhibitor be used.

The exhibitor or decorator must be informed of the characteristics and particularities of the site, as well as the location and size of the elements that may be eventually installed and which must be respected to ensure compliance, such as the clearance height of the building, hoses, fire hydrants, distribution boxes and water pipes or drains existing in the area. Likewise, there must be compliance with the general provisions defined below:

3.1.1. General provisions

The following aspects related to the infrastructure of the venue must be respected when designing, installing and decorating stands:

The walls and columns, as well as the technical installations of the halls must not support any loads on their structure pertaining to decorations or the articles displayed.

Hall columns within the stand can be cladded, without damaging them and in accordance with the permitted height regulations, taking into account the fact that in the case of connection boxes or any other supplies, the said boxes can always be registered.

In the case of cladding or decorating columns with fire equipment, extinguishers, fire alarm call points, signage or any other informational element of the venue, they must always be visible, accessible and clear of obstacles that may prevent their normal use. All of these elements must not be manipulated or disassembled.

All connection service chests/ducts located on the floors of the halls must be easy to register and must be easily accessible at all times. The design of the stand can never obstruct access to any of the service chests. For this purpose, Fira de Barcelona has the power to require compliance with this requirement.



REGULATIONS ON THE BUILD UP OF STANDS AND OCCUPATION OF SPACE

The surface of the exhibition spaces, both inside the hall and in the outer areas, shall solely be carried out by placing a platform or carpeting. This element must be removed by the exhibitor at the end of the event. Likewise, the rear sides of the walls that form the stand shall have a decorative finish.

It is prohibited to drill holes, drive in screws or hammer nails into the walls, ceilings, floors or columns of the halls.

It is prohibited to carry out channeling, bracing or any other structural modifications to the interior of the halls or to the outer areas of the venue. Both the indoor and outdoor exhibition spaces must not be clad with paint or glue.

It is prohibited to apply cement to the floor without the presence of an intermediate protective element authorized by Fira de Barcelona. Furthermore, driving in nails using percussion tools or painting using spray guns is forbidden. Any possible damage caused by the exhibitors or their delegates to the walls, installations or other infrastructures of the Fira de Barcelona exhibition area shall be repaired by Fira de Barcelona and charged to the exhibitor.

Advertising or informative anchors of the halls that are used exclusively by Fira de Barcelona cannot be used.

For safety, health and environmental reasons, the tools that produce dust, such as all types of saws, must not be used inside the Fira de Barcelona halls, unless they are equipped with dust holding bags or suction systems designed for this purpose.

3.2 Shell-scheme or modular structures

These structures may be hired directly through the Fira de Barcelona Sales Department. Their characteristics and prices are specified in the information provided by the Fira de Barcelona Sales Department (www.servifira.com).

3.3 Custom constructions

These structures may be hired directly through the Fira de Barcelona Sales Department (www.buildupfira.com). In this case, the exhibitor must hire the service through the Fira de Barcelona Sales Department for a free no-obligation estimate.

For events organized by Fira de Barcelona and in the case that the exhibitor undertakes a stand construction project through a company hired independently, they must submit the decoration project to the Fira de Barcelona Operations Department in advance for approval (indicating the layout, elevation and other necessary information). This project must be in accordance with the build up regulations of the exhibition, published in the exhibitor area.

As a general rule, the free constructions must comply with the current regulations and, specifically, the Spanish Technical Building Code (TBC) in all of its sections, as well as the basic documents of structural safety (BD SS), fire safety (BD FS) and safe use and accessibility (BD SUA).

The structures of the stand and any of the elements that comprise it must have the necessary stability and rigidity so that they do not pose a risk to people or to the goods of the exhibition, with the safety of the stand under the responsibility of the exhibitor.

3.3.1. Height of the constructions

The maximum permitted height of the stands shall be five (5) meters, provided that the proportions of the stand and the height of the hall allow it and do not obstruct visibility. In the case that the stand exceeds this height, the regulations for complex structures defined below (point 3.4) shall be applied.

Notwithstanding the foregoing, this height may vary depending on the event regulations published in the exhibitor area.

The stands located in the connecting area between halls 4-6 and 5-7, where the maximum hall height is 5.2 meters and the maximum height permitted for the construction is 4 meters, are excluded from this requirement. In this area, it is also necessary to ensure that the path of the smoke deflecting curtains, which reach a height of 2.50 meters with respect to the floor when extended, remains free of obstacles.

Likewise, the construction height is limited to 4 meters in halls 2 and 3, in the area under the connecting walkway of the venue.

In the case of non-compliance with the said regulations, Fira de Barcelona reserves the right to break down or close off the stand, without having to compensate the exhibitor affected, the same exhibitor who shall bear all the expenses arising from the non-compliance of the regulations.

3.3.2. Ceiling Installation

Exhibitors may cover their stands with a ceiling, provided that they observe the technical directives on fire protection and the safety regulations referred to in sections 1.4 and 3.4. Since the ceilings can be seen from higher floors, their finish should always be aesthetically pleasing.

In any case, Fira de Barcelona suggests that when covering the stand with a ceiling, this ceiling is permeable so that the general temperature control of the hall reaches the space of the stand.

In events organized by Fira de Barcelona and in order to achieve a pleasant, harmonious effect, Fira de Barcelona may require changes to be made in the ceiling finishes, even if this entails an additional expense to the exhibitor. The ceiling of a stand must not be completely closed.

3.3.3. Different floor levels due to the installation of platforms

When the floor of the stand must be lifted by installing a platform on the entire surface thereof, it must comply with current accessibility and safety regulations in order to prevent falling to a different level, always in accordance with the provisions set forth in the specifications of the Spanish Technical Building Code.

Under no circumstances shall the access ramp to the platform exceed the limits of the area of the stand, and it must comply with the relevant regulations defined in the Spanish Technical Building Code (BD SUA).

More specifically, it must ensure that the height of the stand platform with respect to the pavement of the hall is never greater than 18 cm.

3.4 Construction of complex structures in the halls and outdoors

Fira de Barcelona may authorize the construction of a complex structure in accordance with the regulations established by the event organizer and in the sections where the ceiling height and the hall structure allow it.

Risk assessment is required to any construction that implies the submission of design floorplans, calculations and certificate of stability approved by qualified technicians. The same applies to all constructions that need a custom evaluation of a special risk assessment.

The complex structures are classified in the following way:

- Shell scheme stands or structures with heights of more than 5 meters. These must have a minimum of three perpendicular support planes throughout their height. Cases where $H > 5m$ are considered complex structures.

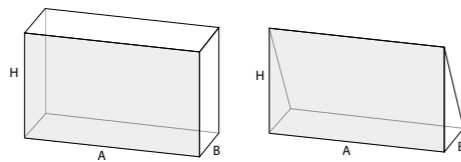

- Structures over 4 meters high. These structures are considered bespoke in totem-type constructions, self-standing partitions or any structure that is not supported by a minimum of three perpendicular faces/sides throughout its height.

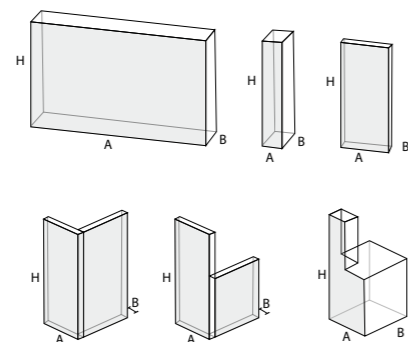

- Double decker stands with access to the upper floor.
- Platforms or stages with access and a height equal to or higher than 0.50 m.
- Tiered seating with access to the general public.
- Outdoor constructions larger than 16 m².
- Constructions smaller than 16 m² and not certified.

The complex structures must comply with the requirements set forth in the current regulations and, specifically, in the contents of all sections of the Spanish Technical Building Code, as well as the basic documents of structural safety (BD SS), fire safety (BD FS) and safe use and accessibility (BD SUA).

Authorization to construct any of these structures must be requested from the Fira de Barcelona Operations Department through the event management team and providing the following documentation:

Pre-build-up

Project designed, signed and endorsed by a certified technician (an authorization statement will be accepted instead of the endorsement).

The project must include:

- A descriptive and explanatory report of compliance with the current regulations.
- Structural study of stability and resistance that considers:
 - Use overload according to table 3.1 CTE DB SE, use category type C.
 - Internal wind pressure of 0.125kN/m² up to a height of 4m, higher than 4m the internal wind pressure will be considered at 0.063 kN/m².
 - Description of the loads on the floor under each support.
- A floorplan and elevation drawings, including details of the handrails and stairs.
- The evacuation and fire detection plan for structures with a surface larger than 100 m².
- Assessment of risks and preventative measures to consider during the construction build up and break down process.

The build-up of each of these structures will have to be supervised by a certified technician authorized by their professional association and will have to issue an approval for this purpose (an authorization statement will be accepted instead of the endorsement).

If all the documentation provided is correct, the build-up of the stand or the structure presented will be authorized. If there is any deficiency identified, the contractor will be asked to correct them. The build-up of the stand or the structure will not be authorized until the deficiencies are corrected.

During build-up

The responsible technician will supervise that the assembly of all the complex structures complies with the conditions established in the documentation provided by the exhibitors.

The request for additional documentation for those structures that are required due to their complexity, even if they are not classified as complex structures as such, will be at the discretion of Fira de Barcelona.

Before the opening

Once the construction of the complex structure has been completed, the responsible technician will issue the corresponding final structural solidity certificate endorsed by the corresponding professional association (an authorization statement will be accepted instead of the endorsement) which will be delivered to Fira de Barcelona.

In the case of a structure certified by an authorized body, the certification of the structure will be presented together with the build-up and breakdown regulations in substitution of the structural study.

For any construction located outdoors larger than 16m², in addition to all of the above, a wind with a speed up to 100 km/hour needs to be taken into account when calculating the structure.

In events organized by Fira de Barcelona and in the case of stands with double decker, these must be designed in such a way that the upper floor in no case exceeds 50% of the total allocated area, and must be placed so as not to impair the visibility of the surrounding stands.

3.5 Small outdoor structures/tents

For tents with a surface smaller than 16m² to be installed outdoors, the exhibitor must provide Fira de Barcelona the approval for these tents by a qualified and authorized organism. These certifications must include the description of its wind resistance and counterweight.

In the event of adverse weather conditions, Fira may request to have the tents closed, folded or withdrawn, or any other compensatory measure (fixings, bracings, ballasts) in order to mitigate risks.

Additionally, arches located outdoors will be properly balanced in order to avoid overturning by winds of up to 100km/h. In this case, the project documentation must include the calculations in order to justify the counterweights, signed by a certified technician. The abovementioned counterweights shall be sufficiently described according to their type (sand bags, water, metal plates, etc.) dimensions and weight.

3.6 Inflatable structures

Inflatable structures, both indoors and outdoors, will have to comply with the UNE-EN 14960:2014 regulations, especially when it comes to ballasts or bracings. Besides, it will be mandatory to dismantle the structure in the event of winds stronger than 38km/h.

Authorization for the construction of inflatable structures shall be subject to the receipt of the following documentation:

- Valid Civil Liability Insurance policy that covers the activity
- Manual of use
- Annual Inspection/homologation/standardization

Once the structure is built and prior to the event opening, it will be necessary to provide a certificate of good construction signed by a representative of the company in charge of the inflatable structure, according to the template to be granted by Fira de Barcelona.

3.7 Regulations for suspending aerial structures (rigging)

The service of basic anchoring points (also called rigging) is exclusive to Fira de Barcelona and offered through its official provider. Therefore, it is entirely prohibited to hang any element directly from the ceiling of the halls and facilities.

The stand exhibitors and build up contractors must request the rigging points according to the load distribution carried out by their qualified technician.

It is not always possible to locate anchoring points in all of the exhibition areas of the hall, since there may be restrictions that depend on the hall and the points already in use, as well as the load capacity of the ceiling. This circumstance may thus require prior adjustment for the rigging (pre-rigging). Moreover, this adjustment may entail additional costs that shall be charged to the exhibitor.

Any exception to the regulations described must be authorized in advance by the Fira de Barcelona technical services.

3.7.1 Basic requirements

The structures must be designed to resist the static and dynamic loads associated with their final design, as well as take into account their steps for build up and break down.

The main requirements for any hanging structure/element are:

- The minimum distance permitted between anchoring points is 1 meter.
- The maximum hanging weight permitted for rigging elements is 15 kg per m², calculated by the ratio of the total weight of the suspended elements to the hired stand surface.
- It is not permitted to raise any truss grid with more than 6 manual chain hoists.
- The maximum load weight of a rigging point is 1.50 kN (150 kg). It must include the weight of the lift equipment (motors, hoists, etc.).
- The hanging elements must have more safety features than those established in the prevailing regulations. This requirement is applied to all principal and secondary, or simply decorative, hanging elements of the points installed by the contractor.
- The loads transferred to the structure at any point due to lifting elements and that act on the halls cannot exceed the maximum load capacity of the point and its elements.
- The materials used must be of a high quality, in a good state, bear the CE (European Conformity) marking and have an up-to-date revision.
- The truss structures and materials belonging to the exhibitors are only permitted if they have the CE (European Conformity) certification and are in excellent working condition.
- Exhibitors are not permitted to hang any element from the auxiliary structures installed in the ceiling of the venue.
- The elements hanging from the ceiling must maintain the vertical nature of the point.
- The maximum recommended distance between the anchoring points that use a truss is 10 meters for general lighting.
- It is strictly prohibited to alter any equipment installed by the official provider, including trusses, wires, shackles or rope slings.
- The maximum height shall depend on the area and hall where the rigging point is installed, and under no circumstances can it exceed the maximum height established by Fira de Barcelona.

3.7.2 Safety wires

Safety wires must be put in place for:

· **Electrical motors and Manual chain hoists**

Safety wires must be installed during the build up, with the purpose of preventing the hanging structure from collapsing. Safety wires must always be used to retain the element that the motor lifts.

Mandatory requirements:

- Safety wires must connect the structures tied by the exhibitor to the ring, bypassing the electrical motor or hoist.
- Once the two ends of the safety wires are secured, these wires must remain slack.
- The diameter of these wires must be at least 6 mm and equal to or larger than the diameter of the main wires.
- Their thickness must support the load associated with the wire plus 25% in order to handle any sudden stress.
- The safety wires must be positioned in such a way that they are not subjected to stress in their final location.

· **For components:**

All hanging equipment and components on a truss (lights, sound equipment and speakers, signs, etc.) must be secured with secondary safety wires/chains and metal flanges.

Mandatory requirements:

- The securing of each unit of equipment must act independently from the secondary equipment and the steel wires must have a diameter of at least 4 mm.
- The safety wires must be made of synthetic fiber in the cases where the main joining system is made of steel wires. However, they will not be used when located near lighting systems.
- The nylon elements must have a minimum tensile strength of 7 kN (700 kg).
- The wires and rope slings made of steel, nylon or a combination of both materials can be used to hang elements.

3.7.3 Request procedure

The rigging points shall be installed by the Fira de Barcelona official provider. Rigging points are not always available and every request will be dealt with individually.

To request the rigging service, it is necessary to fill out the form available online through the Fira de Barcelona Sales Department (www.servifira.com) and submit it along with the documentation listed below:

- A drawing (in AutoCAD 2010, if possible) indicating the height, the weight supported by the anchoring point and the orientation of the stand in the hall.
- The rigging request form (available online at the Servifira website), indicating company information and rigging requirements.
- The point type (with or without safety wires, manual chain hoists or electrical motor).

Based on the complexity of the request (number of points, location, simultaneity of requests, etc.), and at the request of Fira de Barcelona, the following must be submitted:

- A technical description of the design materials.
- Justification of weight calculations of the points.
- Quality certificates of the materials.
- Justification of the revision of motors, hoists or any other machinery.
- A description of the build up/break down procedures to prevent damage to the hall structure or anything which may present a risk to the installations or personnel.

All of the data provided must be submitted with measurements from the International System of Units and in Spanish or English.

In the case of detecting some deficiency in the materials or when completing the work, Fira de Barcelona can stop the build up/break down operations until the required documentation is submitted or the procedures used are corrected.

There are local restrictions that change according to the hall structure, the load capacity of the ceiling and the load already used. These restrictions can lead to the installation of pre-rigging structures with the resulting additional costs. For more information on these restrictions, please contact the Fira de Barcelona Sales Department (www.servifira.com) or write to: rigging.op@firabarcelona.com.

3.7.4 Inspections and period of build up

Fira de Barcelona, through its supervisors and technicians, can conduct inspections or request more documentation during the periods of build up and break down. The build up contractors must carry out the said inspections and provide the documentation required. They must inform the relevant inspectors of any auxiliary element used, such as lift baskets, scaffolding, portable ladders, etc.

If during the build up period there is reasonable doubt over the sustainability of any element, Fira de Barcelona can request viability tests. The costs of the said tests shall be charged to the exhibitor.

Fira de Barcelona, through its designated technicians, can stop the build up or lifting of any structure deemed necessary for safety reasons. For this same reason, it can also request all additional information considered necessary.

3.7.5 Mandatory regulations for the rigging material

EUROPEAN REGULATIONS:

- UNE-EN 13414. Steel wire rope slings. Safety.
- UNE-EN 1677. List of regulations for components of slings. Safety.
- UNE-EN 12385:2003. Steel wires. Safety.
- UNE-EN 13411:2002. Grips for steel wires. Safety.
- UNE-EN 13889:2004+A1:2009. Forged steel shackles for general lifting purposes – straight and curved shackles – Level 6 - Safety.
- Directive 2006/42/EC on machinery

SPANISH REGULATIONS:

- CTE. Spanish Technical Building Code

RECOMMENDED PRACTICES:

- NTP 155: Steel wires
- NTP 221: Steel wire rope slings

3.7.6. Specific regulations on occupational risk prevention

All work at heights must be carried out in compliance with the regulations on Occupational Risk Prevention. Specifically, R.D 2177/2004, of November 12th, which establishes the minimum health and safety requirements for the use of equipment by employees, regarding temporary work at heights.

3.8. Health and safety at construction sites

In application of the criteria of the Labour Authority, the build-up and breakdown of certain elements, facilities and structures such as marquees, stands, stages and sound and lighting support structures may, depending on their characteristics (size, height, use, location, relationship with other facilities, the existence of an implementation project, etc.), be framed within the scope of application of Royal Decree 1627/1997 of 24 October establishing minimum health and safety provisions at construction sites.

It is the event organiser's responsibility to properly frame each activity within the corresponding regulation.

REGULATIONS ON CONFERENCE ROOM BUILD UP

04

REGULATIONS FOR THE BUILD-UP OF PERIMETERED ENCLOSURES OR ROOMS

All construction work of perimetered enclosures or rooms must comply with current regulations and specifically with the Technical Building Code in all its sections, as well as the basic documents on structural safety (DB SE), fire safety (DB SI) and use and accessibility safety (DB SUA). These constructions must always be located inside a Fira de Barcelona hall and, therefore, must be compliant with the general self-protection plan.

A perimetered enclosure or room is considered to be those spaces that have perimeter enclosures, in a percentage equal to or greater than 70%.

4.1 General conditions

The activities or perimeter rooms, built inside a hall, shall be divided into four categories according to their capacity:

Type C1: Spaces with a capacity of less than 50 people. Fira Barcelona does not require additional documentation.

Type C2: Spaces with a capacity of between 50 and 100 people: The organiser or builder must present to Fira Barcelona a project for the room or activity, signed by a certified technician, indicating compliance with the Technical Building Code in all its sections, as well as the basic documents on structural safety (DB SE), fire safety (DB SI) and use and accessibility safety (DB SUA).

Type B: Spaces with a capacity of between 101 and 500 people: The organiser or builder must present to Fira Barcelona a project for the space that is signed by a certified technician, indicating compliance with the Technical Building Code in all its sections, as well as the basic documents on structural safety (DB SE), fire safety (DB SI) and use and accessibility safety (DB SUA). The organiser or builder must also present a certificate of correct execution of the project signed by a certified technician authorised by a professional association.

Type A: Spaces with a capacity of over 501 people or any space, regardless of its capacity, that have tiered seating for audiences as part of the construction: The organiser or builder must present to Fira de Barcelona a project for the room that is signed by a certified technician, indicating compliance with the Technical Building Code in all its sections, as well as the basic documents on structural safety (DB SE), fire safety (DB SI) and use and accessibility safety (DB SUA). In this case, and due to the high number of people and the complexity of the evacuation of the room or activity, a certificate of proper execution issued by the Fira de Barcelona-authorized supplier shall be required. The costs associated with obtaining said certificate shall be covered by the client.

In all cases with the exception of Type C1 spaces, the project to be presented shall be comprised of at least the following:

- Descriptive report and proof of compliance with the CTE.
- Dimensioned floorplan drawings of the room(s) or perimeter activities to be built.
- Evacuation plan, emergency exits, and fire extinguishing measures.

The project must be written in English, Spanish or Catalan.

For these types of rooms, Fira de Barcelona reserves the right to carry out relevant revisions to ensure proper execution of the built projects, and the organiser or builder must correct the issues that may be detected during these revisions.

4.2 Fire safety

4.2.1 Material specification

All materials used must bear the CE (European Conformity) marking. Any material that does not bear the said marking shall require a material test and classification certificate issued by an accredited laboratory for the previous five (5) years. The Fira de Barcelona technical team reserves the right to demand the corresponding certificates.

In accordance with Table 4.1 of BD-FS 1 (basic document on fire safety), the fire resistance of the cladding shall be:

- For walls and ceilings: C-s2 and d0.
- Suspended textile elements: Class 1, in accordance with the UNE-EN 13773:2003 standard.

4.2.2 Calculating capacity (in accordance with Table 2.1 of BD-FS 3), depending on the net surface of each area:

- Designated areas for seated spectators (1 person/seat).
- In the case of more than one exit and for the purposes of calculation, the distribution of occupants between the exits will mean that one of the exits will not be used, in accordance with the worst possible scenario.

4.2.3. Number of exits and length of the evacuation routes (in accordance with Table 3.1 of BD-FS):

- One evacuation exit if the capacity is less than 100 people. Two or more exits if the capacity is more than 100 people.
- The length of the evacuation route to one exit shall be no more than 25 m.

4.2.4. Dimensions of evacuation elements (in accordance with Table 4.1 BD-FS 3):

Doors and aisles: $W \geq P / 200 \geq 0.80$ m.

Width of the door ≤ 1.23 m. Aisles: $W \geq P / 200 \geq 1.00$ m, (where W = width (m), P = total number of people).

Aisles between fixed tiered seating in venues:

1) Seating with an aisle only at one end:

- Maximum of 12 chairs per row
- $W \geq 30$ cm for 7 chairs
- 2.5 cm for each additional chair, up to a maximum of 12 chairs.

2) Rows with exits to aisles on both ends:

- Unlimited aisle in terms of the number of chairs per aisle.
- $W \geq 30$ cm in rows of up to 14 chairs.
- 1.25 cm for each additional chair, up to a maximum of 30 chairs.
- $A > 50$ cm for 30 chairs or more.
- There is no limit in terms of the number of chairs in each row, provided that the evacuation route to the door is no longer than 25 m.

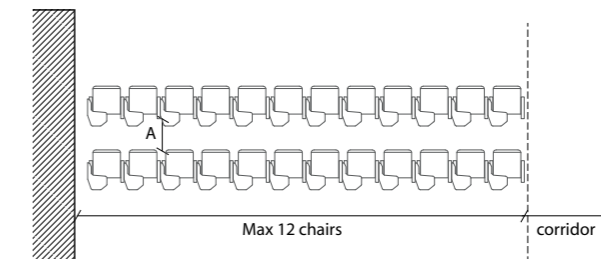

A ≥ 30 cm for 7 chairs
2,5cm for each additional chair up to 12 chairs max.

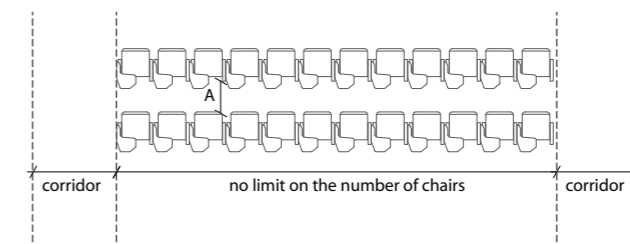

A ≥ 30 cm in rows up to 14 chairs.
1,25cm for each additional chair up to 30 chairs max.
A > 50 cm: For 30 chairs or more. There is no limit on the number of chairs on each row, as long as the escape route until the door is equal or less than 25 metres.

The seats must be joined together to form monolithic rows in cases 1 and 2; a maximum of every 25 rows shall have an aisle between rows with a minimum width of 1.20 m.

Accessibility in accordance with BD-SUA 9:

For every 100 seats or fraction, 1 reserved seat for wheelchair users. Minimum space of 0.80 m x 1.20 m for front access and minimum space of 0.80 m x 1.5 m for side access.

4.2.5. Doors along the evacuation routes

The doors for evacuating less than 50 people must incorporate a quick and easy opening device without having to use a setting key or actuating more than one mechanism. Opening does not necessarily have to occur in the direction of evacuation.

Doors for evacuating more than 50 people must open in the direction of evacuation and by means of a pressure bar or horizontal sliding bar, in accordance with the UNE EN 1125:2009 standard.

The evacuation doors cannot be blocked at any time by any object when there are people in the area.

4.2.6. Signage of the evacuation route

Exits from the area shall have a sign that indicates "EXIT" (UNE 23034:1988).

The "Emergency Exit" sign must be used at all exits that are to be used exclusively in the case of emergency (UNE 23034:1988).

They must have indicative signals for the direction or routes, visible from all evacuation points of origin.

The signals must be visible even in the case of a power failure in the lighting.

4.2.7. Fire protection installations

The fixed fire protection installations located inside the hall shall remain accessible and visible at all times.

There shall be extinguishers in accordance with the TCB. In accordance with Table 1.1 of BD-FS 4:

Portable extinguishers: one with an effectiveness of 21A-113B.

- A maximum of 15 m with respect to any evacuation point of origin.
- In special areas of risk (i.e. cloakrooms and luggage storage, kitchens, etc.)

No fire detector in the hall may be blocked. Contact Fira de Barcelona if necessary.

4.2.8. Signs for manual fire protection installations

The signs must be in accordance with the UNE 23033-1 standard, with the following sizes:

- 210 x 210 mm if they are visible at a distance of under 10 m;
- 420 x 420 mm if they are visible at a distance of 10-20 m;
- 594 x 594 mm if they are visible at a distance of 20-30 m.

4.3 Safe use and accessibility

4.3.1 Unevenness in the floor

In accordance with BD-SUA 1, the floor must fulfill the following requirements:

- It shall not have joints that protrude more than 4 mm.
- The small isolated elements that protrude from the floor level shall not protrude more than 12 mm.
- The protrusions larger than 6 mm on surfaces oriented towards the flow of people cannot form an angle greater than 45° with respect to the floor.

4.3.2 Protection of unevenness in stairs and stages

In order to prevent falls, and in accordance with DB-SUA 1, the builder needs to create differences in height on stairs, ramps and stages that do not exceed 55cm, both through visual and tactile perception. This differentiation will start at least 25 cm from the edge.

05

REGULATIONS ON TECHNICAL SERVICES FOR STANDS

5.1 Water and drainage services

In the case of events organized by Fira de Barcelona, the exhibitors who need to use water and drainage must disclose this in the participation application (for better placement distribution). Likewise, they must fill out the corresponding contracting form included in the Exhibitor Services Catalogue (www.servifira.com) and send it to Fira de Barcelona at least two (2) weeks before the build up starts.

There are water and drainage outlets in the halls: the thread pitch of the existing installation is 1/2" and the drainage duct is 40 mm. The connection of the water and drainage installation of the stand to the Fira de Barcelona fixed installation shall always be carried out by the Fira de Barcelona technical personnel. Pressure tubes with threading on both sides must be used for the ducts.

The water pressure in the Fira de Barcelona distribution ducts is supplied by the general water company, this pressure being four (4) bars. For apparatus that needs constant pressure, the use of regulators and, if applicable, devices that increase the pressure is recommended.

Fira de Barcelona will install a hose from the connection in the service chest to the point indicated by the exhibitor for connecting the installation to their stand. A shut-off valve will always be installed at the end of the hose. The water network from the connection point to the Fira de Barcelona fixed installation is the responsibility of the exhibitor, except when Fira de Barcelona has contracted the water installation of the stand.

In the case of requiring water or a drainage service at a point where there is no supply, the Fira de Barcelona technical service should be contacted through the event management team for the possibility of temporarily installing a water supply at the said point. This will be charged to the client.

Fira de Barcelona does not accept responsibility for the possible interruptions or irregularities in the distribution of general water by the company.

5.2 Compressed air services

The Gran Via venue has a compressed air distribution network. The connection is made through the service chests.

The available pressure is seven (7) bars with an approximate flow of 1.000 l/m.

The connection to the installation will be made by means of a 1/2" ball valve with a thread-type connection or quick connection, with the first option recommended.

Fira de Barcelona has oil and water filters in its installations. However, the recommendation is for the exhibitor to have their own filtering equipment.

REGULATIONS ON TECHNICAL SERVICES FOR STANDS

Likewise, the exhibitor must install an air dryer if they require specific humidity conditions.

To have the compressed air supply service, contracting must be carried out by completing the corresponding contracting form included in the Exhibitor Services Catalogue (www.servifira.com) and sending it to Fira de Barcelona at least two (2) weeks before the build up starts.

In the locations where Fira de Barcelona cannot provide exhibitors with this service, the use of compressors shall be authorized, following the revision and verification of the project, to those who require it, and charged to the exhibitor, taking into account the following regulations:

Compressors:

Compressors can be located inside the stand, provided that the appropriate sound insulation measures are adopted to prevent noises that bother other exhibitors. The maximum noise volume permitted cannot, under any circumstances, exceed three (3) dB above the background level.

Fira de Barcelona reserves the right to stop the operation of a compressor in the case of exceeding the indicated noise level.

The installation of the compressor must take into account the necessary precautionary measures in order to avoid the loss of oil or other fluids that may harm the event's image.

All air pressure installations with a maximum allowable pressure greater than 0.5 bars require an installation certificate. The said pressure shall be calculated by finding the result of the products with the maximum operating pressure (MOP) of the equipment comprising the installation (in bars) multiplied by the volume (in liters) of all units of pressure equipment permanently connected to the installation.

- An installation certificate without a project, for those installations with a result of $MOP \times V \leq 25,000$.
- An installation certificate with a project, for those installations with a result of $MOP \times V > 25,000$.

When using gasoline or gasoil compressors or compressors of any other fuel, these should also be located outside the hall of the exhibition area.

Bottles:

Only one reserve bottle of compressed air shall be permitted in order to continue providing the service inside the halls. The said bottle shall never exceed 200 Nm3 (category 1 according to ITC MIE-APQ-5).

In the case that the exhibitor requires a place to store additional bottles, they must contact the Fira de Barcelona technical service through the event management team to discuss this specific requirement.

In any case, there must always be compliance with the provisions of the current regulations on Pressure Equipment RD 2060/2008 and the regulations on Chemical Product Storage RD 379/2001 and applicable supplementary technical instructions.

5.3 Installation of air conditioning systems

All halls of the Fira de Barcelona venue have temperature control systems during both the winter and summer seasons, maintaining the proper temperature inside the halls, according to the current regulations on temperature control in spaces open to the public, and in accordance with the Regulations on Thermal Installations in Buildings (RITE) and the amendments contained in RD 1826/2009.

In the case that the use of individual air conditioning units is strictly necessary, the reasons, location and type of individual temperature control systems proposed for their authorization, as well as the expected periods of use, shall be communicated in advance to the Fira de Barcelona technical service through the event management team.

Only the installation of equipment with condensation circuits that are air-cooled shall be permitted. The installation of equipment that uses water or another type of coolant in an open circuit is not allowed. The operation of evaporator cooler equipment that uses water and does not comply with the provisions of RD 865/2003 is not permitted either.

As a general rule, the return air of this equipment cannot be expelled inside the hall nor into the adjacent exhibition areas, and the return air must be guided to an area outside the hall through the proper ducts. To do so, the technical viability study for the location and securing of these ducts must be requested from the Fira de Barcelona technical services through the event management team. In terms of the technical viability of the project, the costs of carrying out the authorized installation shall be charged to the exhibitor.

Fira de Barcelona reserves the right to stop the operation of equipment if it creates unacceptable disturbances for other exhibitors or for the event in general.

5.4 Gas installations and elements that generate combustion or inflammable gases

The emission of vapors, inflammable gases or toxic gases that may be a health hazard or bothersome to the attending public or other exhibitors is not permitted.

The gases and vapors generated by the fuel must be evacuated to an outside area through the ducts provided for the said purpose. To do so, the technical viability studies for the location and securing of these ducts must be requested from Fira de Barcelona. In terms of the technical viability of the project, the costs of carrying out the authorized installation shall be charged to the exhibitor.

In any case, there must be compliance with the provisions of the technical regulation on the distribution and use of gaseous fuels RD 919/2006 and its supplementary technical instructions IG01 to 11.

With regard to generating odors that may bother the rest of the exhibition area, a hood with filters suitable for absorbing the said odors must be installed.

If there is a need to use domestic gas, the installation and the gas supply must be legalized by a company authorized for the said purpose, delivering the corresponding report to the Fira de Barcelona hall manager.

5.5. Welding equipment and hot work

For safety reasons, cutting and welding work cannot be carried out without the prior corresponding authorization of Fira de Barcelona. The work area must be examined and approved by the Fira de Barcelona manager present at the hall before signing the corresponding authorization.

This type of work shall not be authorized in the following cases:

1. In the presence of carpeting, wood, paper or any other inflammable material.
2. In areas or equipment that have not been especially conditioned.
3. With cutting and welding equipment that is not in a good state of use.
4. By unqualified people.

Conditions for the authorization of cutting and welding work:

1. All potential risks of fire or explosion, such as combustible materials, paints, oils, fats, solvents and compressed gases, must be removed from a radius of twenty (20) meters.

2. There shall be an operational extinguisher that will be placed 2 meters from the work.

3. The work area shall be protected with fire-resistant elements (safety screens).

4. In the case of electric welding, the machines must have their respective ground line.

5. The areas of electric-arc welding must be visually isolated from the rest of the work environment.

6. In the case of oxy-fuel equipment, the bottles must be secured to their corresponding cart by means of metal chains or clasps. Each portable cart with welding equipment must be equipped with a 6 kg ABC powder extinguisher.

7. Sixty (60) minutes after completing the work, the area must be examined by an authorized person.

8. Personal protective equipment suitable for the work to be carried out:

- A safety helmet
- Glasses or facial screens, with filter glass, that protect from the violent projection of particles and radiation from welding.
- Protective elements for hands, arms, legs and the body against heat and mechanical risks.
- Safety footwear.
- Cotton work clothing (flame-resistant and fitted).
- In poorly vented areas, the use of protective masks with filters for metal fumes.

5.6 Installation of antennas and radio signal transmitting and receiving stations

When it is necessary to install antennas or radio signal transmitting and receiving stations (television antennas, parabolic antennas, repeaters, broadcasters, walkie-talkie systems, GPS antennas, etc.), an installation project proposal must be submitted to Fira de Barcelona for its verification and approval. Once the project is approved, it must be legalized in the case that, given the nature thereof, it is so required and in accordance with the current regulations, and governed at all times by the provisions of RD123/2017.

Access to the spaces for carrying out the build up and break down of this equipment shall always be coordinated and led by the Fira de Barcelona technical personnel. All costs incurred by installing and legalizing the installation shall always be charged to the exhibitor.

5.7 Limitations to the build up of stands and adaptation of exhibition spaces

The walls and columns, as well as the set of technical installations of the halls, must not support any loads on their structure caused by decorations or the articles displayed. No construction elements can be supported by or onto walls, columns or other fixed elements of the halls, and adequate protection must be used or a safe distance must be maintained between the construction materials and the hall walls. In no case should the stability of any object, assembly or structure be conditioned to the infrastructure of Fira de Barcelona. All elements must be self-supporting and self-standing.

Hall columns inside the stand can be cladded without damaging them and in accordance with the permitted height regulations, taking into account the fact that, in the case of connection boxes, these boxes can always be registered. Vinyl columns can only be installed by official Fira suppliers. This service can be contracted through the sales department of Fira Barcelona (www.servifira.com)

In the case of cladding or decorating columns with fire equipment, extinguishers, fire alarm call points, signage or any other informational element of the venue, they must always be visible and accessible. They cannot be manipulated or broken down.

All connection service chests located on the floors of the halls shall always be registered and must be easily accessible at all times. The design of the stand can never obstruct access to any of the service chests.

The surface of the exhibition spaces, both inside the halls and outdoors, shall solely be carried out by placing a platform or carpeting which must be removed by the exhibitor or decorator at the end of the event.

It is prohibited to drill holes, drive in screws or hammer nails into the walls, ceilings, floors or columns of the halls.

It is prohibited to carry out channeling, bracing or any other structural modifications to the interior of the halls or to the outer areas of the venue. Both the indoor and outdoor exhibition spaces must not be cladded with paint or glue.

It is prohibited to apply cement to the floor without the presence of an intermediate protective element authorized by Fira de Barcelona. Furthermore, it is prohibited to drive in nails using percussion tools or to paint using spray guns.

The Gran Via venue has escalators, travellers and public elevators. This equipment cannot be used to transport, lift or move elements for constructing or decorating stands. For this purpose during the periods of build up and break down, this equipment shall be temporarily kept out of use.

Any possible damage caused by exhibitors or their delegates to the walls, installations or other infrastructures of the Fira de Barcelona exhibition area shall be repaired by Fira de Barcelona and charged to the exhibitor.

Supporting construction elements or elements of any other type on the walls, columns or other fixed elements of the halls is prohibited. Proper protection must be used or a safe distance must be maintained between the construction materials and the hall surfaces.

5.8 Ramps for accessible routes

In accordance with DB-SUA 1, the ramps will have a maximum slope of 10% when their length is less than 3 m, 8% when their length is less than 6 m and 6% in all other cases.

Ramps with a slope larger than or equal to 6% and with a height of more than 18.5 cm, will have continuous handrails throughout their entire length, including the floors, on both sides.

Likewise, the free edges will have a plinth or side protection element of at least 10 cm high. When the length of the section exceeds 3 m, the handrail will extend horizontally at least 30 cm at the ends, on both sides.

An exception of not placing a railing can be made, provided that the report written by the certified technician is correctly justified.

5.9 Smoke detectors

Enclosed roof structures are allowed to be built provided that the specifications of the construction, decorative or furniture materials, established in these regulations, are met. The certificates must comply with the prescriptions of the CTE, DB SI-1, table 4.1, Euroclasses, DIN 4102-B1 or their equivalent standards.

Relevant certificates must be available for presentation upon request.

- Stands with closed ceilings, up to 6m high that do not allow smoke to escape, must have smoke detectors and a CE-certified fire alarm system installed.

- A minimum of one smoke detector is required for every 60m² of closed ceiling, it means that a closed ceiling of 100m² requires a minimum of two smoke detectors.

- In narrow corridors and covered spaces less than 3 m wide, the minimum distance between detectors must be 15 m.

- For stands with less than 100m² of enclosed space, independent and autonomous smoke detectors with integrated alarms are accepted as long as they are certified by the CE standard and comply with the following points:

- Stands smaller than 100m², ground floor only
- The length and width dimensions are less than 10m.

Please note: conventional textile ceilings are classified as solid ceilings and will require smoke detectors.

General exceptions

Textile wire mesh ceilings without a smoke detector are acceptable if they are fire rated M0, M1 or M2 (Euroclass A, B or C) and have a minimum opening of 2mm x 4mm or 3mm x 3mm. Textile ceilings must be single-ply and horizontally stretched.

Ceilings made with metal mesh without a smoke detector are accepted if they are fire resistant M0, M1 or M2 (Euroclass A, B or C) and have a minimum opening of 10 mm x 10 mm.

Stands with more than 100m2 of closed space or double decker stands

Stands with closed spaces below a second level (regardless of surface area) or with more than 100m2 of closed space will require the following:

· A professional smoke detector system that meets the requirements of UNE 23007-14: 2009 including:

- Alarm buttons
- Interconnected smoke detectors
- Control Panel
- Certified by a local authorized and certified provider
- At least one smoke detector per closed room
- The smoke detector system must be connected to the Fira Control Center through a communication device that must be hired from servifira
- The smoke detector system requires a 24-hour power supply to function properly.

It is recommended to contact servifira to obtain a quote on the installation by the official Fira supplier of these systems. Below is a list of some of the requirements for such installations as an example:

- Alarm buttons should be placed so that anyone within these spaces does not have to move more than 25m to reach/press the alarm button. In places where users are expected to have limited mobility, the distance traveled should be reduced. In general, the buttons should be placed at a height of between 1.2 m and 1.6 m from the ground.
- The sound of the fire alarm must have a minimum level of 65 dB (A) or 5 dB (A) above any other noise that is likely to persist for a period of 30 seconds if this level is higher. The sound level should not exceed 120 dB(A) at any point where people are likely to be present.

INSTALLATIONS AND POWER SUPPLY REGULATIONS

06

INSTALLATIONS AND POWER SUPPLY REGULATIONS

6.1 Power supply

All electrical energy supplied to the stand shall be provided by Fira de Barcelona, the characteristics thereof being 400 V between phases and 230 V between phases and neutral.

A direct current supply or a supply in any other condition of stability and continuity which differs from the general supply and does not belong to Fira de Barcelona will be charged to the stand exhibitor and requires the prior authorization of Fira de Barcelona.

Fira de Barcelona may limit the supply power when it may have a negative effect on other users or through the risk of overload or the safety of its own lines and installations.

The users of the stands and installations are required to maintain a $\cos \phi$ power factor of between 0.95 and 1.

In the case that the installed electricity-consuming equipment requires some type of precaution in the shutdown processes or is sensitive to possible cuts in the power supply, the equipment installer must install elements that prevent the risk of a possible power supply failure, such as uninterruptible power supply (UPS) systems.

Since the power supply of the Gran Via venue depends on the power company providing the services, Fira de Barcelona is not responsible for the external defects thereto, including both supply failure and the quality thereof (variations in frequency, variations in voltage, transitions, spikes, sags, short outages, micro-cuts, etc.).

6.2 Legalization of the installation

All installations must be carried out in accordance with the requirements required by the Low-Voltage Electrotechnical Regulations (LVER) and the supplementary technical instructions thereof by an electrician officially authorized by the Industry Department of the Generalitat of Catalonia, in compliance with the corresponding electrical installation report (official certificate).

EU electricians who do not have the official Catalan electrician license are required to register themselves at any of its offices. Next, they must also register themselves with an ICO (Inspection and Control Organization).

Non-EU electricians must make Fira de Barcelona directly responsible for the electrical distribution switchboard. If Fira de Barcelona is not made responsible for the electrical distribution switchboards, the stand constructor or exhibitor, if applicable, shall ensure that this service becomes the responsibility of an officially certified electrician in Catalonia or a European electrician who has prior experience in carrying out the aforementioned procedure.

All exhibitors who do not make Fira de Barcelona responsible for an electrical distribution switchboard of the stand must fill out the electricity request form in order to have a power supply in the stand. Electricity consumption will be billed before the event and Fira de Barcelona must have received payment for the installation to be approved and to ensure electricity at the stand.



The electrical connections in the Gran Via venue are made by using CEE PLUG 3P+N+T 6h three-phase connectors.

To legalize the electrical installation, the documentation of the installation, duly certified by an electrical installer authorized by the Generalitat of Catalonia, must be delivered to the Fira de Barcelona Industry Service (present in the Customer Service Offices), providing the necessary documentation:

Stands with up to 50 kW shall require a technical design report that must include the following documentation:

- Electrical installation report.
- Electrical diagram with calculations.

Stands with more than 50 kW must be legalized by means of a technical project created by a licensed engineer. This means:

- A project stamped by the Catalonia School of Engineers.
- A stamped certificate for completion of the work.
- An electrical installation report.

All installations powered by a generator must also be legalized in the case that the said generator exceeds 10 Kva.

The costs of legalization, carrying out the project and the necessary documentation shall always be charged to the exhibitor. Fira de Barcelona may provide the service for carrying out the projects if so required by the exhibitor.

It must always be taken into account that the electrical distribution in a stand must be legalized by a sole owner, the legalization being separate for each stand. In the case of stand islands for several exhibitors, each of the stands must be legalized separately in accordance with Industrial Safety Law 12/2008 of July 31st.

6.3 Electrical connection to service chests or exhibitor boxes

The power supply in the halls shall be exclusively activated by the Fira de Barcelona personnel, and it shall be provided once the electrical installations of the stand have been approved and authorized by the corresponding Industry Service present in the Fira de Barcelona Customer Service Office.

In the Gran Via venue, connections up to 63 A shall be made by means of a CEE PLUG 3P+N+T 6h form with the proper intensity (16, 32 and 63 A, three-phase). The physical connection to the outlet must be made by the electrical installer of the stand, who shall note the number of the electrical base used.

For consumption greater than 63 A, the stand switchboard shall be directly connected to the service line that Fira de Barcelona will install, and the TN-C distribution system must be used.

6.4 Power supply through service lines

When the power supply is greater than 63 A, the available connection points have been used up or a power supply is required in areas without services, an electrical service line connected to the Fira de Barcelona fixed installations must be installed.

This service line consists of a cable hose and a switch for supply to the exhibitor. This final switch can sometimes be omitted upon providing the supply in an exhibitor switchboard. This installation shall be carried out by the Fira de Barcelona technical personnel.

In this case and for all purposes, the point where the electrical service line installed by Fira de Barcelona ends shall be considered the starting point of the electrical installation of the stand.

When it is necessary to install an electrical service line, it must be requested from the Fira de Barcelona Sales Department (www.servifira.com) two (2) weeks prior to the start of the event build up. The costs associated with the installation of a service line shall be charged to the exhibitor requiring the service.

6.5 Electricity distribution of the stands

The following requirements must be fulfilled:

- The main electrical distribution switchboard of the stand must incorporate a main breaker with heat and magnetic protection.
- The use of fuses is not permitted.
- The main breaker must be adjusted to the power requested to Fira de Barcelona.
- All lighting circuits and exits of less than 32 A must be protected by a residual-current protective device of 30 mA. Likewise, all electrical equipment accessible to the public must also be protected by a residual-current protective device of 30 mA.
- All circuits must be protected against current overload with omnipolar cut (phase-neutral) at its source.
- All distribution switchboards must be able to be opened solely with the use of a tool.
- In covered areas, the distribution switchboards must have a minimum protection level of IP 4X, and, in open areas, the degree of protection will be IP 45.
- The distribution switchboards of the stands must be duly fixed to the structure at a height between 1 m and 1.80 m and must be accessible.
- Electrical switchboards that do not fulfill the conditions set forth in the Low-Voltage Electrotechnical Regulations (LVER), according to technical instruction, shall not be accepted.

6.6 24-hour or permanent switchboard

When the distribution switchboards and their electrical connections require a supply for 24 hours, they must be independent of the daytime distribution switchboards and exhibitors must contract Fira de Barcelona, expressly indicating the timetable for the 24 hours. Likewise, they must be legalized with the Industry Service, clearly indicating that they will be used for 24 hours.

Switchboards that have been previously contracted for daytime use cannot be extended to 24 hours; in this instance, the exhibitor must contract a new permanent switchboard (24 hours).

6.7 Electrical shut down

Fira de Barcelona shall establish off time for the electrical circuits during the event and once the said event has finished. This off time shall be applied to both the daytime switchboards (during the event) and the 24-hour switchboards (once the aforementioned event has finished). In the case of requiring a power supply after this time, the corresponding request must be made to Fira de Barcelona 24 hours prior to the final show day.

It is the responsibility of the company carrying out the break down to check, prior to the commencement of the works, that there is no voltage throughout the entire work area of their stand.

6.8 General conditions for installing and contracting a power supply

In the case of contracting through the Fira de Barcelona Sales Department (www.servifira.com):

- All services are provided on a rental basis.
- Exhibitors who hire electrical switchboards through Servifira delegate to Fira de Barcelona the management of their installation.
- Power consumption and the corresponding fees are included in the cost of the electrical switchboards.
- The rental prices of the electrical switchboards for show days include the legalization thereof but not the electrical project in the case it is equal to or greater than 50 kW in the stand.
- The electrical consumption rates are open to any possible official variations that may occur.
- In any case, only the supply of goods and services contracted at least two weeks prior to the commencement of the build up is guaranteed. Fira de Barcelona shall not process any order that has not been previously paid for.
- Fira de Barcelona accepts no responsibility for interruptions to the power supply due to causes beyond its control.

With regard to the electrical installation of the exhibitor (Fira de Barcelona has not been contracted):

- The exhibitor must pay the amount of electricity consumption and the corresponding fees through the Fira de Barcelona Sales Department (www.servifira.com).
- The cost of electricity consumption derived from the show day switchboards shall be billed according to the fees and the full requested power (power of the stand + extra power).
- The electrical consumption rates are open to any official variations that may occur.
- Fira de Barcelona accepts no responsibility for interruptions to the power supply due to causes beyond its control.

07

CLEANING AND WASTE MANAGEMENT REGULATIONS

Fira de Barcelona has a comprehensive cleaning and waste removal service. This service can be hired through the Fira de Barcelona Sales Department (www.servifira.com).

In events Fira de Barcelona organizes it will offer the general cleaning service for the venue and halls, according to requirements, including corridors, common areas, bathrooms, rooms, etc.

In the case that the event organizer is not Fira de Barcelona, the organizer must pay the costs of the general cleaning service for the contracted spaces and the corresponding access points.

7.1. Stand cleaning

In the events organized by Fira de Barcelona, the basic cleaning service (sweeping the floor, emptying trash bins and cleaning horizontal surfaces of the standard furniture) is included in the stands contracted by the companies that participate in the exhibitions organized by Fira de Barcelona.

With regard to requesting additional cleaning services (vacuuming, washing, cleaning glass and vertical surfaces, etc.), these shall be hired through the Fira de Barcelona Sales Department (www.servifira.com). This cleaning shall be carried out at night to minimize the impact of the service during show days.

Exhibitors who decide to use a cleaning service other than Fira de Barcelona shall duly verify their personnel, and the service must be carried out during the time established by the exhibitor and the electrical connection requirements must be fulfilled for the installation of the stand.

For the stands that are not properly cleaned, Fira de Barcelona reserves the right to clean them at the cost of the exhibitor.



CLEANING AND WASTE MANAGEMENT REGULATIONS

7.2. Waste removal

The company responsible for the construction or decoration of the stand will be responsible for removing the waste generated daily, during both the build up and break down periods.

The fire prevention policy prohibits the accumulation of waste in the stands and their storage areas, as well as in the corridors and common areas. For this purpose, the build up contractors can have a waste container inside the venue. Waste must be removed at the end of each day. Only the collection of material within the limits of the stand is permitted.

The removal of generated waste can be managed through one's own means or by hiring the service through the Fira de Barcelona Sales Department (www.servifira.com). Waste removal companies other than Fira de Barcelona must be verified in order to offer their services in the venue and to pay the corresponding fees required to gain access.

In the events organized by Fira de Barcelona, the Waste Control service shall be responsible for providing information and it may sanction cases of non-compliance with the regulations. The official sanctions can be consulted with the Customer Service Office.

It is not permitted to use the bathroom sinks for the build up and break down work; the indicated industrial sinks must be used for these activities.

Remember that batteries, oils, light bulbs, paint, solvents and, in general, any toxic or chemical product must be duly recycled.

At the end of the break down period, the contracted surface must be completely clean, which includes removing the adhesive carpet tape and any other material. Once this period has finished, the stand exhibitors that still have waste will be charged the cost of cleaning and waste removal to restore the conditions of the contracted space.



08

TECHNICAL REGULATIONS FOR SHOW DAYS

8.1 Use of machines and tools during the event

All exhibition machines or tools must have the CE approval and must be identified with the corresponding marking. In the case of exhibition machinery that does not have the CE approval, it must comply with the provisions of Article 3 of RD1644/2008.

The exhibitor shall equip the installations that must function during the event with the protective devices necessary for the work and accident prevention required by the technical regulations defined for the said installations.

The work areas or parts of the machines that may generate a risk of entrapment, cutting, abrasion or projection must be marked with the appropriate warnings and danger signs and must be equipped with protective devices suitable for eliminating the risk.

All machines or tools must be equipped with emergency stop devices that allow their operation to be stopped under safety conditions.

It is entirely prohibited that the safety devices of the machines are stopped or disconnected to prevent the use thereof during the demonstrations.

The personnel who operate the machine during the demonstrations must have received the proper training and information regarding the machine operations and the risks of its use.

For cases in which these regulations are violated and where the operation of the machinery potentially poses a risk to people, Fira de Barcelona is authorized to demand that it is stopped or, likewise, that it does not become operational. The exhibitor or organizer shall be responsible for complying with the said regulations, as well as the consequences derived from non-compliance.

8.2 Use of projection during the event

In events organized by Fira de Barcelona, it is not permitted to show logos, trademarks or projections outside of the scope of the exhibition stand, whether it be by using projectors, lasers or light beams.

In the case of using laser projection for lighting or the setting, the apparatus used must have the corresponding authorization and approval certificate from the manufacturer.

8.3 Maximum noise level permitted

In the shows held at Fira de Barcelona all activities and product demonstrations that may generate noise inside the halls during the hours of the show days, as a service to other exhibitors (when necessary), shall be limited to the maximum noise level permitted, which corresponds to three (3) dB above the background level. In all cases, the maximum noise level admitted in the exhibition area shall never exceed sixty (60) dB. Should the allowed noise level be exceeded, Fira de Barcelona shall require the exhibitor to lower the volume until it reaches the proper levels.

TECHNICAL REGULATIONS FOR SHOW DAYS

When noisy activities are carried out outside the venue, the organiser shall check the City council current regulations to verify the maximum noise level allowed. As a guideline, the acoustic limitation can vary between 40dBs and 65dBs approx. depending on the area as well as the time frame of the event.

In musical events, parties or activities after 22h both indoors and outdoors with noise impact likely to disturb the residents in close proximity to the event, it is required to hire a noise control service in order to monitor the noise level from the activity in real time.

The cost of this technical supervision and noise control service of will be covered by the petitioner of the activity.

Fira de Barcelona reserves the right to demand the reduction of the noise emitted or to entirely stop it when the admissible sound levels (dB) are exceeded and has the authority to restrict activities that do not comply with the provisions of the said section.

It must be also taken into account that the Gran Via venue strictly limits night-time activities outside (between 10 pm and 6 am), both during the periods of the build up and breakdown and during the show days and in determined areas, specifically:

- In the side streets of halls 6 and 7 (adjacent to C/ Alumini),
- The rear area of halls 5 and 7 (C/ Mileva Maric),
- The loading bay area of hall 8 (C/ Alts Fornes).

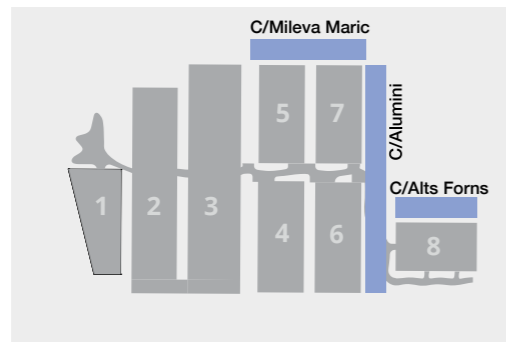

8.4 Photographic and audiovisual recordings

Regulations applicable to all events organized by Fira de Barcelona

Photographs

None of the products displayed may be photographed or filmed without the express authorization of the exhibitors. Fira de Barcelona has the right to photograph, film or draw the installations and the stands, as well as the products displayed, and to use these reproductions in their publications and in the press.

Each exhibitor has the right to photograph his/her own stand and articles, but the photographer must request authorization from the corresponding event management team for the necessary control. The duly authorized photographer shall present himself/herself to the Hall Services Manager and can only photograph the applicant exhibitor's stand and articles.

Should the photographs be taken outside of the event opening hours, prior authorization must be requested from Fira de Barcelona. If it is necessary to turn on the lighting, the electrician authorized by Fira de Barcelona is required to be at the desired location. The resulting costs shall be charged to the exhibitor. Exhibitors can also make use of the photography service provided by Fira de Barcelona that is included in the Fira de Barcelona Sales Department (www.servifira.com).

Film screenings and musical reproductions

Exhibitors who wish to liven up their stands using mechanical or electronic apparatus or image reproducers are required to request the copyrights and relevant authorizations for public communication of the works from AGEDI or the entity that, in each case, manages the rights of public communication of the phonograms of the producers, as well as from SGAE or the entity that manages each case.

If films are to be screened, the exhibitor must apply for the appropriate authorization of the public communication thereof from the entity that manages the public performance rights in each case.

Those exhibitors who wish to carry out a show and have leisure activities accompanied by musical auditions must inform Fira de Barcelona for authorization. All of this without prejudice to the authorizations and permits that must be requested from the qualified bodies, entities and administrations. There must always be compliance with the current legislation on data protection, image rights and all regulations related to the sections described above.

8.5 Catering

Fira de Barcelona is able to provide catering services to exhibitors who so require it through the Gastrofira Catering Department (www.gastrofira.com).

Exhibitors who are going to offer catering at their stand and do not wish to hire Fira de Barcelona services must obtain the health and hygiene authorization described below. This authorization will be necessary for all operators or providers who serve or sell food considered to be a risk in the Fira de Barcelona venues.

In the events directly connected to the food sector, and in the case of sampling services at stands, the company hiring the space (the exhibitor) shall be responsible for the prime condition of the food that it provides, but without the need to present the health and hygiene authorization.

8.5.1. Necessary document requirements (documents to be provided)

A. Health and hygiene authorization in effect for points of sale or food services at Fira de Barcelona.

B. The lack of the aforementioned authorization means the following shall be required:

- A signed document of the commitment to comply with the current law on food hygiene (Regulation EC 852/2004). The model is included in Annex III.
- Photocopy of the Health Record or the corresponding health permits marked by RD 191/2011.

- Manual Self-Monitoring System based on the Hazard Analysis and Critical Control Points system.
- Training records of food handlers.
- A list of existing allergens in the products offered.

8.5.2. Basic requirements for installations (to be verified on-site)

- A drinking water installation (sink with tap and drainage), required in the case of handling food at the stand.
- Smooth, impermeable and easy-to-clean work surfaces.
- Installations for the cold storage of food (when the product needs it).
- Trash bins with a non-manual opening lid.
- Cooking or heating on a stove is not permitted inside the halls of the venue; the material to be used for this purpose must be electric. Any gas installation is prohibited if it does not comply with the requirements established in point 5.4 (gas installations).
- A 24-hour electrical switchboard for refrigerators and machinery that needs a permanent supply.
- Operators or providers who need water installations must contract the supply and drainage point, as well as the electrical switchboard, power and industry fees through the Fira de Barcelona Sales Department (www.servifira.com).

Fira de Barcelona does not accept responsibility for interruptions or irregularities that may occur in the water or power supply. This is the responsibility of supplier companies.

8.5.3. Minimum Basic Requirements of Good Practices of Handling (EC 852/2004)

Reference samples of all foods to be consumed by more than 50 people must be stored. These samples must be frozen for five days after the event. Personnel must follow good practices of personal hygiene (refrain from wearing jewelry, use head coverings if necessary, do not use rags, or wooden utensils, etc.).

Food transport with refrigerated means to avoid breaking the cold chain. Use of exclusive uniforms for carrying out the work.

All employees must be in good health (no colds, no poorly covered wounds, etc.) in order to ensure the prime condition of the food.

The documentation referred to in the first point must be sent at least fifteen (15) business days before the start date of the service to the following address in order to validate its content. E-mail: Iriera@saia.es / kromani@saia.es; Tel: +34 931 841 048; Fax: +34 931 841 049.

The cost of the authorization to provide the service shall always be charged to the exhibitor. For the said purpose, the authorized auditor company shall issue the corresponding invoice, which must be paid by the provider/operator, and the receipt of the transaction.

Once the receipt of the transaction has been received, the authorized company shall issue the certificate authorizing the sale or service of food in the Fira de Barcelona exhibition areas. The certificate shall be valid for one year after the date of acquisition.

During the show days of the event, on-site audits shall be carried out to verify compliance with the different requirements.

8.5.4. Group audits with reduced rates

Under circumstances in which an organizer is responsible for managing the documents of more than one operator/provider and where audits can be carried out at the same place and time, the cost of the rates applied shall be scaled.

8.5.5. Catering waste removal

All catering companies must remove waste during the build up of the stand, as well as clean their space once the break down period has ended. Leaving trash in the containers located in the exhibition area is strictly prohibited. In the case of non-compliance with the present regulations, there shall be sanctions with a waste removal fee or even the prohibition of entry into the exhibition area.

External catering companies must rent at least one 240-liter container per stand one day before having access to the vehicle entry passes. For this purpose, they must contact the Fira de Barcelona Sales Department (www.servifira.com) to hire the containers.

If necessary, services for renting containers and removing their debris and waste may be hired through the Fira de Barcelona Sales Department (www.servifira.com).

8.5.6. Catering vehicle passes

The health and hygiene authorization does NOT include vehicle passes. The Fira de Barcelona Hall Manager must be contacted to reserve and organize, prior to the event, the vehicle pass for external catering companies.

Each vehicle pass intended for catering deliveries includes three (3) passes for personnel, one driver and two (2) service staff, for the entire duration of the event.

Important: The vehicle passes must be requested at least 72 hours prior to the commencement of the event in order to be able to issue the three personnel passes. Only commercial vehicles shall have access to the venue; private cars will not be admitted.

8.6 Connectivity services

Exhibitors, as well as build up contractors, are prohibited from installing or using Wi-Fi networks other than those offered by Fira de Barcelona.

To everyone's benefit, all Wi-Fi connections shall be operated by Fira de Barcelona. Fira de Barcelona uses specific equipment from the build up period of the exhibition until the end. Any other Wi-Fi network must be authorized and its disconnection will be required; in this instance, economic sanctions may be applied.

In cases where the exhibitors require the installation of their own Wi-Fi network, which differs from the one offered by Fira de Barcelona, authorization can be requested from the Networks and Communications Department (internet@firabarcelona.com), where the case will be discussed with the local expert team, and will be either accepted or denied.

If the request is accepted, the configuration and regulations will be indicated in detail, in addition to agreeing on a date and time with the local expert team to validate the configuration before the inauguration of the event.

Recommendations for exhibitors

The use of any equipment, Wi-Fi network or any other technology that operates on the 2.4 GHz or 5 GHz frequencies, such as wireless microphones or wireless light controls, is not permitted. If the use of this equipment is necessary, the Networks and Communications Department must be contacted (internet@firabarcelona.com).

If an internet connection is essential to the exhibitor, they should contact the Networks and Communications Department (internet@firabarcelona.com) prior to the event or contract a cable internet service.

In the case that the devices (mobile devices, PCs, etc.) can only connect through Wi-Fi, they should be compatible with the 5 GHz frequency (standard Wi-Fi 802.11a/n/ac). Any device that is not compatible with 5 GHz will not function with any product hired through point 12.1 ONLINE SERVICES CATALOGUE. Fira de Barcelona shall not accept any claim or refund request for devices that are not compatible with 5 GHz.

Fira de Barcelona has the latest Wi-Fi network with more than 1,200 antennas distributed through the venue to ensure the best service possible. The installation of Wi-Fi networks not authorized by Fira de Barcelona generate interference, thereby worsening the services it provides and the service of the other exhibitors. We ask that exhibitors use the service offered by Fira de Barcelona.



Short video about the service

8.7 Exhibition of vehicles in stands

Vehicles with combustion motors used as exhibition articles in closed spaces must have their tanks filled with only the minimum amount of fuel necessary to access the space of the stand and to be able to leave it until the event ends. Vehicles cannot be started during the event show days unless the specific regulations thereof expressly authorize it.

In this case and to keep the vehicle started for an extended time during the exhibition, in addition to the process of placing and removing the vehicle, the exhaust gases must be removed to the outside of the hall through the connection in the exhaust pipe for sucking gases that is connected to the evacuation ducts. To define the location of and to secure these ducts, the technical viability study must be requested from the Fira de Barcelona technical services through the event management. In terms of the technical viability of the project, the costs of carrying out the authorized installation shall be charged to the exhibitor.

8.8 Exhibition of animals in stands

The exhibition of live animals must be carried out in accordance with the EU regulatory provisions and any other applicable legislation, including the existing municipal regulations in L'Hospitalet del Llobregat and Barcelona.

EXTRAORDINARY ACTIVITIES DURING SHOW DAYS

09

EXTRAORDINARY ACTIVITIES DURING THE SHOW DAYS

9.1 Creation of “artificial fog” in events and festivities inside the halls

The creation of smoke inside the halls is not permitted. Exceptionally, Fira de Barcelona can authorize at specific times (parties, presentations, etc.) the creation of “stage smoke” or “artificial fog”, generated by specific machines for that purpose, during a short period of time and provided that they comply with the specific conditions defined by Fira de Barcelona.

Authorization must be requested from the Fira de Barcelona safety service through the event management team in advance, indicating the area that will be affected and the length of time the “artificial fog” will be created. Under no circumstances may the “artificial fog” affect the spaces that are not rented by the creator thereof, which subsequently means this technique may not be used in exhibitions with different exhibitor stands.

Fira de Barcelona shall have additional safety measures, for both the personnel’s safety and the adjustment of the technical control equipment in the hall to create the “artificial fog”. The costs for using these additional resources shall be charged to the exhibitor who wishes to produce the artificial fog effect.

9.2. Use of drones during the event

For drones in flight or in motion, Fira de Barcelona must be notified in advance in order to approve them. These drones must weigh less than two (2) kg.

Furthermore, the drone owners must provide the following documentation:

- A technical data sheet for the drone, including a photograph thereof.
- A signed statement of responsibility (attached). Create annex.
- A visible notice if the drone records images (Law on Data Protection).
- RC policy and damages with coverage of at least €300,000.

To carry out the demonstrations, both in halls and outdoors, with the drone in flight (even with a restraint cord), a net must be installed around the perimeter of the stand or in the area of flight in order to avoid accidents and damage to people or goods in the rest of the exhibition. This protective net and the demonstration must have prior authorization from the Fira de Barcelona Safety Department through the event management team.

The personnel who carry out the flight demonstration of the drone must have a drone pilot license (necessary for drones heavier than two (2) kg) or a document that certifies their capacity to handle drones, according to RD 8/2014 of July 4th.

9.3. Other activities

All activities not mentioned in this document shall always require the prior authorization of Fira de Barcelona in order to carry them out. For the said purpose, the project of the activity and a descriptive report thereof must be provided to Fira de Barcelona, including all the necessary documentation for its assessment by Fira de Barcelona in order to analyze the viability of the proposed activity.

10

REGULATIONS ON VEHICLE ACCESS IN THE EXHIBITION AREA

10.1 Build up and break down process

10.1.1 Build up process

Exhibitor companies with outstanding unpaid balances with Fira de Barcelona shall not be permitted to commence the build up of a stand, regardless of the exhibition, edition, or event to which the debt relates.

The period and times of build up and break down shall be adjusted to the dates indicated in the exhibition calendar. They are determined for each event according to the corresponding participation regulations. However, this period shall be divided between the build up activities of the stands and the arrival of merchandise.

If for any reason the build up of a stand had to be moved to a time prior to the dates indicated, the exhibitor must request the corresponding authorization from the Fira de Barcelona Customer Services Department, which in turn shall grant authorisation on the basis that the capacity of the halls allows it. In this case, the costs derived from the said extension shall be charged to the exhibitor (surveillance, electricity service, etc.). In terms of requesting an extension of the timetable during the official build up and break down days, this shall be requested through the Fira Hall Manager before 12 pm on the day of the extension.

Fira de Barcelona reserves the right to modify the build up periods and timetables if necessary.

10.1.2 Access to the halls

Access to the halls, as well as the loading and waiting areas, shall be defined in each case according to the characteristics of the exhibition, with the proper indications provided by means of detailed plans of the exhibition area.

During the days of build up and break down, Fira de Barcelona reserves the right to permit or restrict the entry of exhibitor vehicles to unload or load merchandise (depending on the material in the vehicle to be unloaded), as well as permitting or restricting the entry of exhibitor vehicles in the stand for its removal.

The access of private vehicles in the venue shall not be permitted during the days of build up and break down.

10.1.3 Break down process

The break down period shall be adjusted to the dates indicated in the exhibition calendar.

This period shall be divided between the break down activities of the stands and the shipment of merchandise. Likewise, different break down periods can be established for different halls depending on the characteristics of the exhibition and provided that the exhibition calendar is respected.

REGULATIONS ON VEHICLE ACCESS IN THE EXHIBITION AREA



Exhibitors who have outdoor stands and, in particular, those located on the avenues and squares of the exhibition area must break down their installations in the 48 hours following the end of the exhibition in which they participated.

The break down and shipment of merchandise shall be finalized before the period of break down concludes. Fira de Barcelona reserves the right to break down a stand or move the merchandise contained within if the said final date has passed, and in the process the exhibitor will be charged with the additional costs. Fira de Barcelona shall not be responsible for the damages that the said materials and merchandise may suffer.

Fira de Barcelona reserves the right to modify the break down periods and timetables if necessary.

10.2 Access to the exhibition area for loading and unloading activities

Fira de Barcelona shall indicate in each case the guidelines for regulating the entry of vehicles into the exhibition area and halls. Likewise, their time of admission before, during and after each exhibition held in the exhibition areas shall be limited.

Fira de Barcelona has a system for controlling the access and stay of vehicles inside its venues, the purpose of which is to guarantee the maximum length of stay of the vehicles to load and unload merchandise.

Vehicles may remain inside the venue only during the loading and unloading activities of the merchandise. Once the said activities have been finalized, the vehicles must leave the inside of the exhibition area, and can use the outdoor parking lots.

Vehicle category types

Low vehicles: vehicle clearance \leq 2 m.

Average vehicles: vehicle clearance between 2 and 3.5 m.

High vehicles: vehicle clearance $>$ 3.5 m.

Implementation fees

Fees according to the vehicle category (low, average and high).

Cost of access to the venue and number of hours the vehicle can remain in the exhibition area.

Important:

Vehicles are strictly forbidden from staying the night in the exhibition area beyond the timetable established in each exhibition. If this requirement is not fulfilled, the driver shall be sanctioned with a fine defined in the fees stated at the access points to the venue.

The regulations on circulation, as well as the existing road signs and speed limits, must be respected at all times inside the venue.

It is prohibited to park in areas of influence corresponding to the emergency exits, as well as in the access points that may be reserved for emergency services.

10.3 Arrival and shipment of articles and merchandise

All merchandise intended for Fira de Barcelona shall be clearly identified (venue, hall, stand no. and exhibiting company) and must be received by the exhibitor.

The arrival of merchandise to the halls that make up the exhibition area must be coordinated so that the people authorized by the exhibitor can receive the material at the unloading site.

Under no circumstances shall Fira de Barcelona be responsible for receiving the said merchandise. The responsibility of the exhibition materials corresponds solely and exclusively to the authorized exhibitor and build up contractor.

10.4 Services for empty packaging

Fira de Barcelona offers a packaging holding service which includes removal, holding and return-to-stand of packaging materials. This exclusive service may be contracted, where the exhibitor fills out the corresponding services catalogue sheet or directly contacts the Fira de Barcelona Sales Department (www.servifira.com).

The exhibition halls and the exhibition area must be free of packaging 24 hours before the event is held. On the contrary, Fira de Barcelona shall order the removal thereof, with the costs incurred charged to the exhibitor.

The packaging shall be collected once the exhibitor has identified them with the relevant label that will have been previously supplied by the official provider. To obtain labels, it is necessary to have signed a packaging (or materials) contract with the official provider in advance.

All materials that are not duly identified with their corresponding packaging label shall be considered waste and will be removed by the cleaning company on the last day of the build up.

The packaging is returned once the event has ended. Exhibitors usually have one hour after the official ending time to vacate the halls (subject to modification if thus required by the conditions). The return of packaging and materials is essential, and, in general, no other logistics services will be carried out while it occurs.

The return of 100% of the materials during the last day of the event and before the following day when the official break down begins is ensured.

Fira de Barcelona accepts no responsibility for the packaging material that is not removed in due time. It is not permitted to store containers, packaging materials, or any inflammable material in the stand.

10.5 Arrival of installations and merchandise from abroad (outside the EU)

Customs with the "0851 – Trade Fair" code, linked to the Barcelona Provincial Customs Clearance and Special Taxes Office, operates in the Fira de Barcelona venues.

From January 2017, all customs procedures are carried out online under the control of the Main Customs Office of Barcelona. The business hours are from 8:30 am to 2 pm at the Main Customs Office on Passeig de Josep Carner, 27.

Relevant information:

Non-EU materials and merchandise, without free circulation and sent to the exhibition area, must be formally documented with the EU Transit documentation (T.1), Internal Transit issued by other EU customs or with the ATA Carnet (in accordance with the Customs Code Regulation no. EU952/2013).

The transits that reached the exhibition area 0851 must be completed by the customs agent representing the exhibitor, generating the corresponding summary declaration. The DUA (single customs declaration) of Temporary Importation shall be submitted with the summary declaration within 24 hours of the arrival of the merchandise to the venue.

When Temporary Importation presented after the 24-hour period is admitted as an exception, the Inspection Service shall impose a sanction for failing to comply with this regulation.

If, due to the kind or class of merchandise shipped, it is subject to controls by Health, Veterinary Health, SOIVRE or Phytosanitary measures, the said merchandise will be regulated at all times by the provisions of the current legislation, in effect prior to their exhibition.

Packaging should be clearly marked with the name of the exhibition where it will be displayed, followed by Fira de Barcelona. The name of the exhibiting company, the exhibition area (Montjuïc or Gran Via), the exhibition hall number and the stand number must also be indicated. Once the event has finished and before the merchandise is shipped, the exhibitor must submit a written declaration to Customs of the samples, brochures and other advertising material originating from non-EU countries which have been distributed, and which material is still in their possession.

Once the event is over, the re-shipment of materials and merchandise must be processed through Customs 0851.

If the exhibitor decides to definitively import their items and is in possession of the necessary documentation for this purpose, Customs 0851 will arrange dispatch.

If merchandise is not properly documented on the Departure Transit form (T.1), ATA Carnet or the DUA of Temporary Importation, this will result in the initiation of the appropriate action to obtain the relevant duties and taxes. Likewise, the shipment of merchandise without canceling the Temporary Importation document will result in action being initiated to obtain the relevant duties and taxes and the corresponding sanction.

The Customs Zone of the Fira de Barcelona venue handles both incoming and outgoing merchandise but there is no provision for storage due to the high number of transactions carried out. For this reason, once the break down period has come to an end in accordance with the provision of the specific Regulations governing each event, the exhibitor shall transfer their merchandise to a holding area or Duty-Free Zone, assuming all costs incurred.

For additional information on customs and dispatch requests, we suggest that you contact Resa Expo Logistics (official provider of Fira de Barcelona) operations@resaexpo.com; Tel: +34 93 233 47 42.

10.6 Parking service

The Gran Via venue has parking lots reserved for exhibitors and visitors. In the events thus taken into consideration, exhibitors may request parking spaces through the sales channels, where the available spaces, as well as the corresponding dates, hours and prices will be identified. The access height of the underground parking lots is 2 m.

TECHNICAL DATA ON HALLS AND EXHIBITION SPACES

11

TECHNICAL DATA OF HALLS AND EXHIBITION SPACES

11.1. Technical data of the Gran Via exhibition areas

The table of basic technical data of the halls and exhibition areas of the Gran Via exhibition area is attached.

11.2. Floorplans of the Gran Via exhibition areas

A set of the layout plans of the different halls is attached, indicating the surfaces, the main dimensions and the distribution of services.

Likewise, the distribution of the different convention centers of the Gran Via venue is included, indicating the possible capacities according to the furniture distribution.*

* The furniture represented in the distribution plans will not necessarily be available for all the rooms or convention centers; these distribution plans simply provide an indicative distribution of maximum capacities.



11.1 TECHNICAL INFORMATION

		Hall 1	Hall 2	Hall 3	Hall 4	Hall 5
Surface	m2	14.000	32.000	43.000	20.000	17.000
Dimensions	meters	102 - 51 X 203	90 X 393	95 X 415	81 X 218	91 X 202
Height	beam (m.)	10	13,4	10,44	10,44	11
	arcade (m.)	-	5,2	8,9	8,9	-
Columns	number	29	146	46	18	40
Max weight	kg/m2	3.000	5.000/1.800	5.000	5.000	3.000
Doors (meters)	number	5	20	16	8	9
	height (m.)	5,8	4,2	5	5	6
	width (m.)	6,7	5	6	6	6
Goodslift	number	0	0	0	0	0
	capacity	-	-	-	-	-
Air Conditioning	cooling	Yes	Yes	Yes	Yes	Yes
	heating	Yes	Yes	Yes	Yes	Yes
	air change	Yes	Yes	Yes	Yes	Yes
Compressed Air	pressure	Service Ducts (6,5 Bar)	Service Ducts (6,5 Bar)	Service Ducts (6,5 Bar)	Service Ducts (6,5 Bar)	Service Ducts (6,5 Bar)
	flow rate	700-1.000 l/min.	700-1.000 l/min.	700-1.000 l/min.	700-1.000 l/min.	700-1.000 l/min.
Electricity		Service Ducts 400/230 V	Service Ducts 400/230 V	Service Ducts 400/230 V	Service Ducts 400/230 V	Service Ducts 400/230 V
Water Drainage		Service Ducts	Service Ducts	Service Ducts	Service Ducts	Service Ducts
Data & Telecom	RJ45	Service Ducts	Service Ducts	Service Ducts	Service Ducts	Service Ducts
TV Satellite TV		Service Ducts	Service Ducts	Service Ducts	Service Ducts	Service Ducts

		Hall 6	Hall 7	Hall 8.0	Hall 8.1	Link 4-5	Link 5-7
m2		20.000	17.000	14.000	10.500	3.370	1.870
meters		81 X 220	91 X 202	79 X 174	79 X 161	37 X 94	37 X 62
beam (m.)		10,44	11	6,70	10	5,20	5,20
arcade (m.)		8,9	-	-	-	-	-
number		18	40	42	16	25	17
kg/m2		5.000	3.000	3.500	1.500	1.000	1.000
number		8	9	3	-	1	1
height (m.)		5	6	6	-	-	-
width (m.)		6	6	4,75	-	9,4	9,4
number		0	0	0	5	0	0
capacity		-	-	-	3.5 / 6.0 Tn	-	-
cold		Yes	Yes	Yes	Yes	Yes	Yes
hot		Yes	Yes	Si	Yes	Yes	Yes
air change		Yes	Yes	Yes	Yes	Yes	Yes
pressure		Service Ducts (6,5 Bar)	Service Ducts (6,5 Bar)	Service Ducts (6,5 Bar)	Service Ducts (6,5 Bar)	Service Ducts (6,5 Bar)	Service Ducts (6,5 Bar)
flow rate		700-1.000 l/min.	700-1.000 l/min.	700-1.000 l/min.	700-1.000 l/min.	700-1.000 l/min.	700-1.000 l/min.
		Service Ducts 400/230 V	Service Ducts 400/230 V	Service Ducts 400/230 V	Service Ducts 400/230 V	Service Ducts 400/230 V	Service Ducts 400/230 V
		Service Ducts	Service Ducts	Service Ducts	Service Ducts	Service Ducts	Service Ducts
RJ45		Service Ducts	Service Ducts	Service Ducts	Service Ducts	Service Ducts	Service Ducts
		Service Ducts	Service Ducts	Service Ducts	Service Ducts	Service Ducts	Service Ducts

Available services in service ducts

Compressed Air	2 Compressed Air connections 1/2" at 6,5 bars
Electricity	1 socket outlet CETAC 63A. 5 poles
	2 socket outlets CETAC 32A. 5 poles
	4 socket outlets CETAC 16A. 5 poles
Water & Drainage	2 water connections 1/2" at 4,5 bars
	1 general drainage with two 32 mm branches.
Data & Telecom	8 connectors RJ45 voice & data
TV / Satellite TV	1 distributor with two coaxial sockets TV thread

11.2 VENUE FLOORPLANS

HALL	m ²
1	14,000
2	32,000
3	43,000
4	20,000
5	17,000
6	20,000
7	17,000
8.0	13,800
8.1	12,700

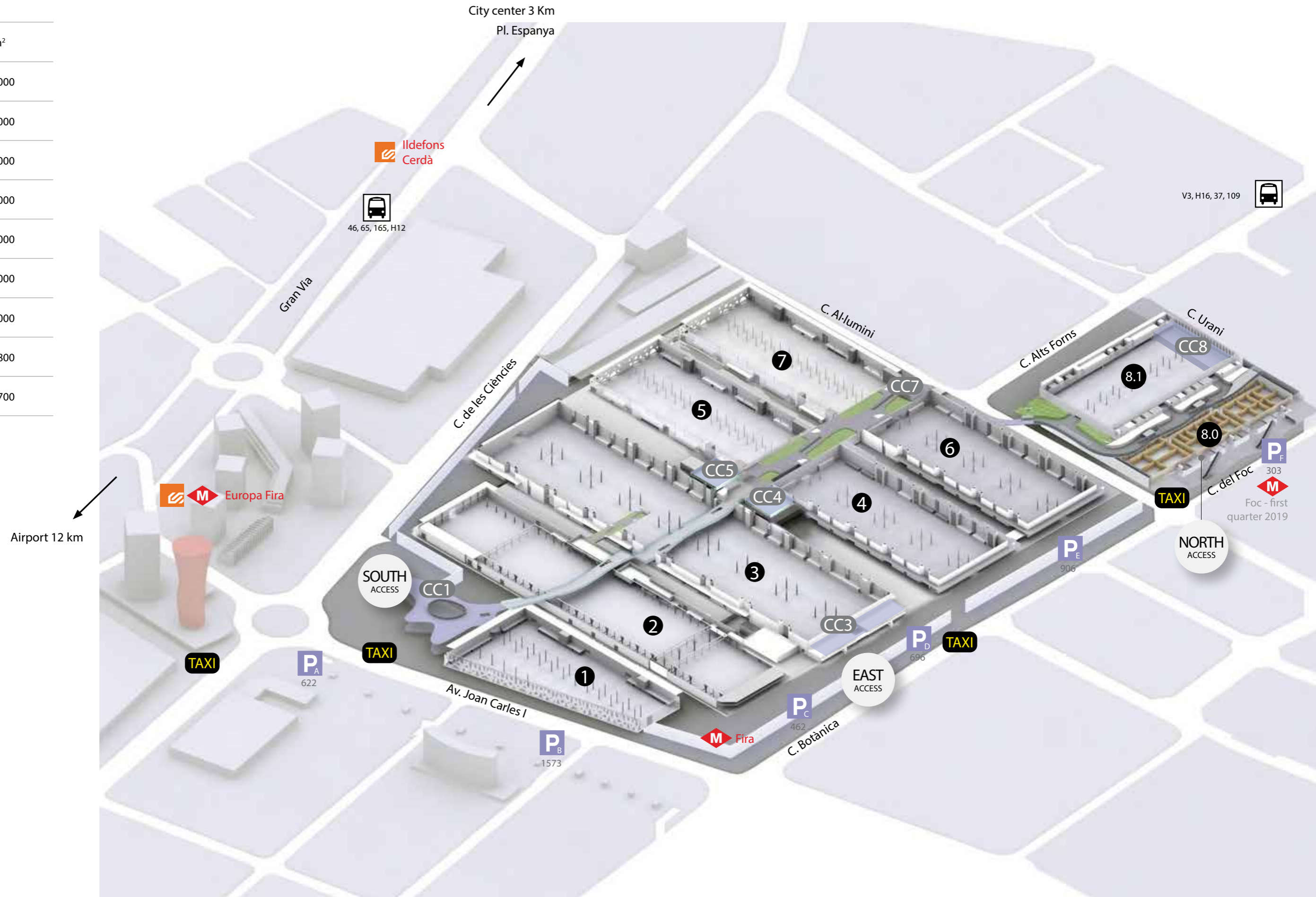

-  Metro
-  FGC
-  BUS
-  TAXI
-  Parking

HALL 1

Gross Surface	14,000 sqm
Ground Resistance	3,000 kg/sqm
Height	11m

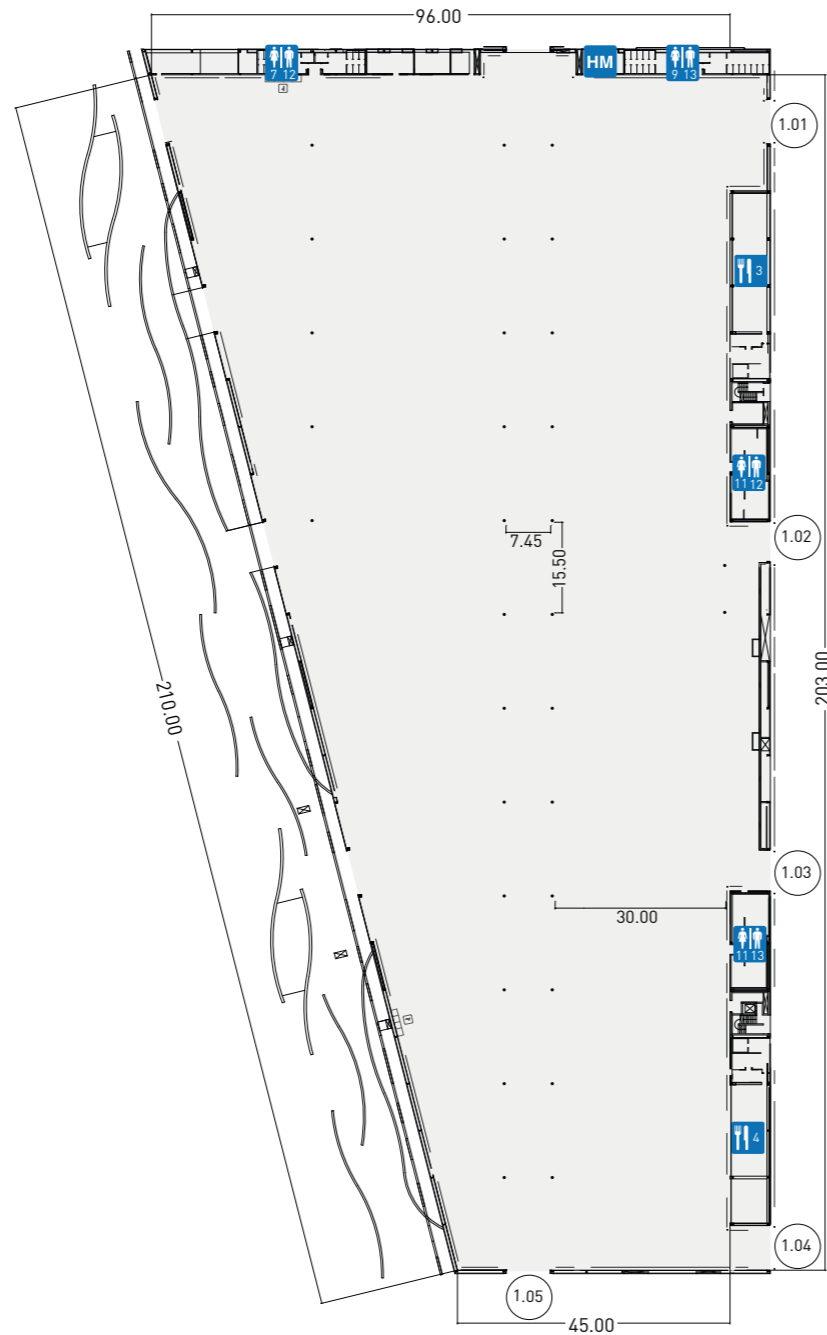
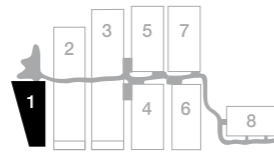

- Outlet
- Cloakroom
- WC
- Hall manager
- Info point

FOOD OUTLET CAPACITIES

	INDOORS	OUTDOORS
Outlet 3	80	120
Outlet 4	80	120

HALL 2

Gross Surface	32,000 m2
Ground Resistance	5,000 kg/m2
	1,800 kg/m2
Height	9.50 -12m

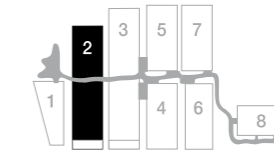

- Outlet
- WC
- Hall manager

FOOD OUTLET CAPACITIES

	INDOORS	OUTDOORS
Outlet 5	30	-
Outlet 6	50	180
Outlet 7	50	60
Outlet 8	100	130
Outlet 9	65	90

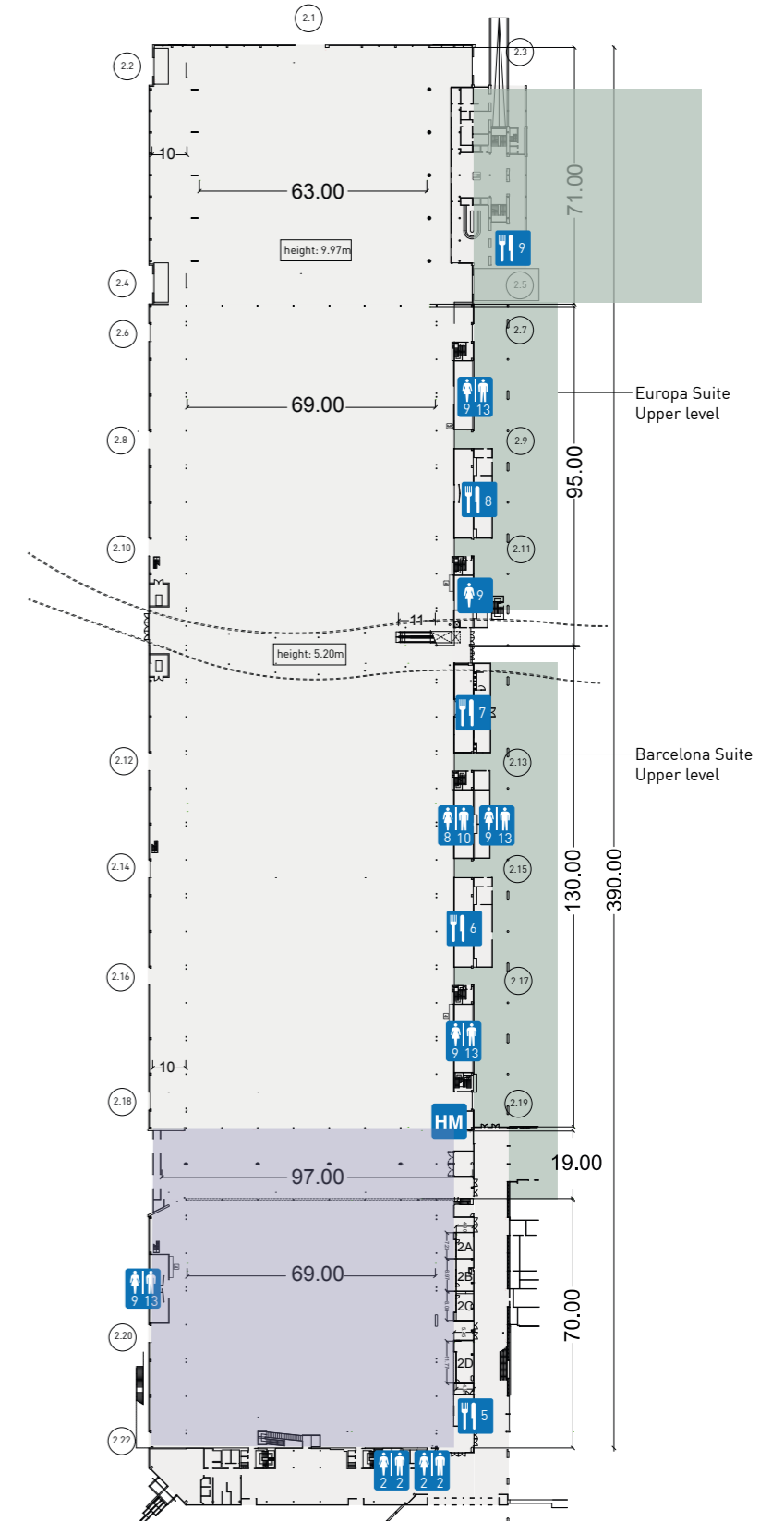

HALL 3

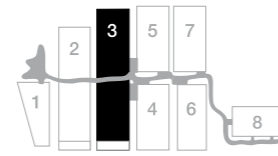

Gross Surface	43,000 m ²
Ground Resistance	5,000 kg/m ²
Height	12 - 15.8 m



- Outlet
- Cloakroom
- WC
- Hall manager
- First aid
- Info point
- Registration counter

FOOD OUTLET CAPACITIES

	INDOORS	OUTDOORS
Outlet 11	550	-
Outlet 12	60	108
Outlet 13	60	108
Outlet 14	60	108
Outlet 15	60	108
Outlet 16	180	-
Outlet 17	50	-
Outlet 18	50	-
Outlet 19	50	-
Outlet 20	50	-
Outlet 21	50	-
Outlet 22	50	-

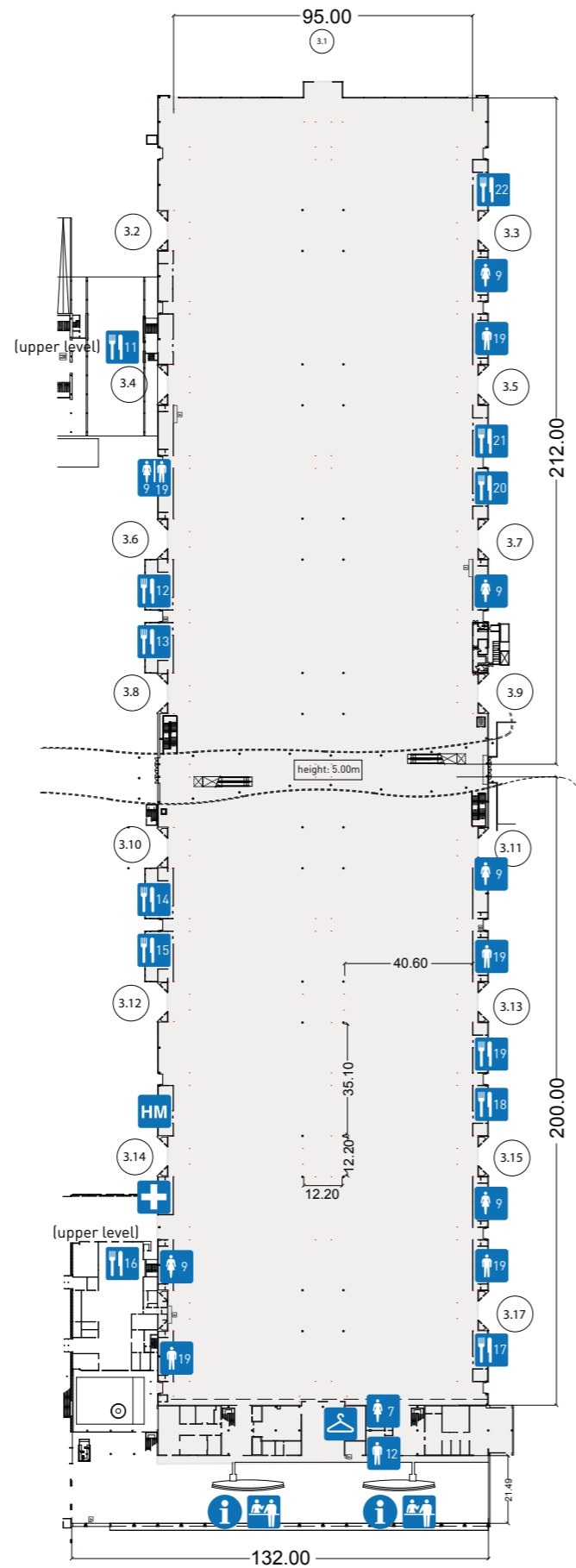

HALL 4

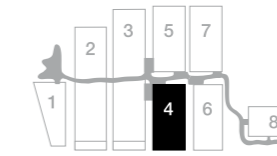

Gross Surface	20,000 m ²
Ground Resistance	5,000 kg/m ²
Height	12 - 15.8 m

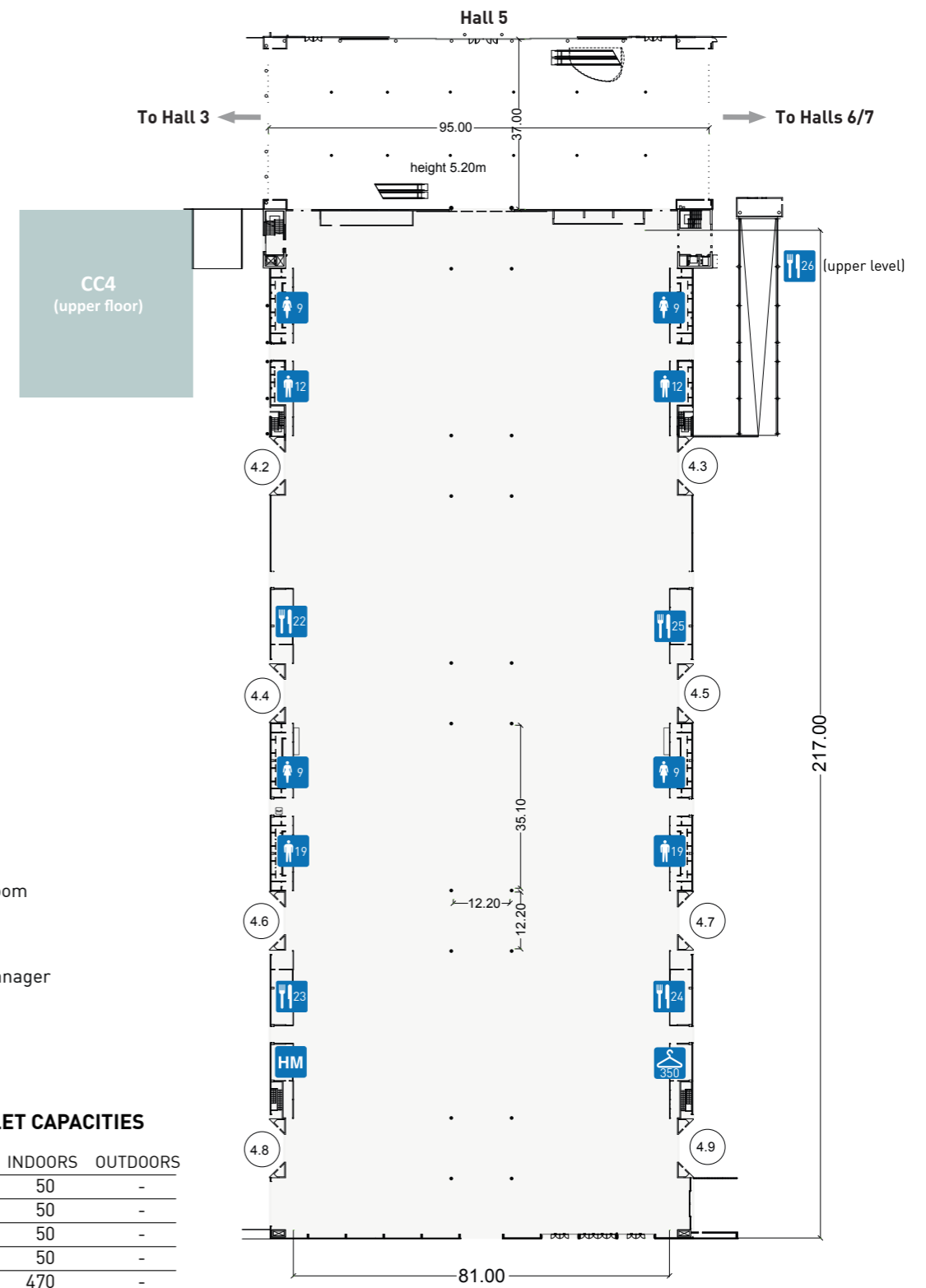

- Outlet
- Cloakroom
- WC
- Hall manager

FOOD OUTLET CAPACITIES

	INDOORS	OUTDOORS
Outlet 22	50	-
Outlet 23	50	-
Outlet 24	50	-
Outlet 25	50	-
Outlet 26	470	-

HALL 5

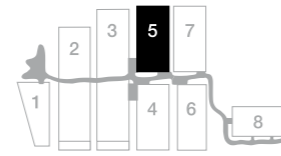

Gross Surface	17,000 m2
Ground Resistance	3,000 kg/m2
Height	11 m

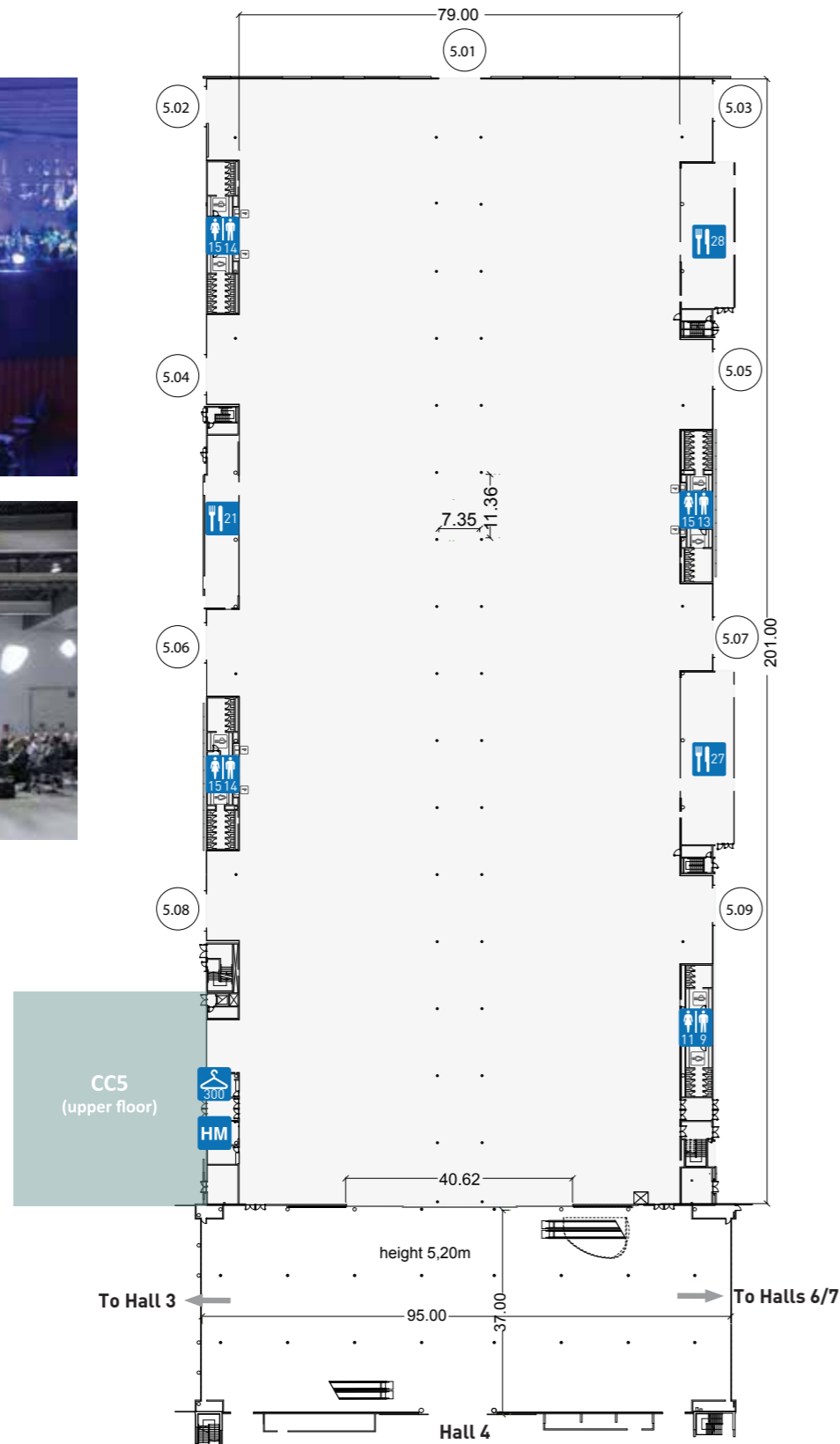

- Outlet
- Cloakroom
- WC
- Hall manager

FOOD OUTLET CAPACITIES

	INDOORS	OUTDOORS
Outlet 21	80	140
Outlet 27	100	100
Outlet 28	100	140

HALL 6

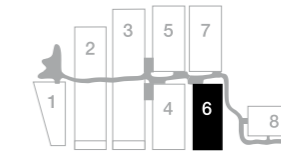

Gross Surface	20,000 m2
Ground Resistance	5,000 kg/m2
Height	12 - 15.8 m



- Outlet
- Cloakroom
- WC
- Hall manager
- Info point

FOOD OUTLET CAPACITIES

	INDOORS	OUTDOORS
Outlet 26	420	-
Outlet 31	50	-
Outlet 32	50	-
Outlet 33	50	-
Outlet 34	50	-

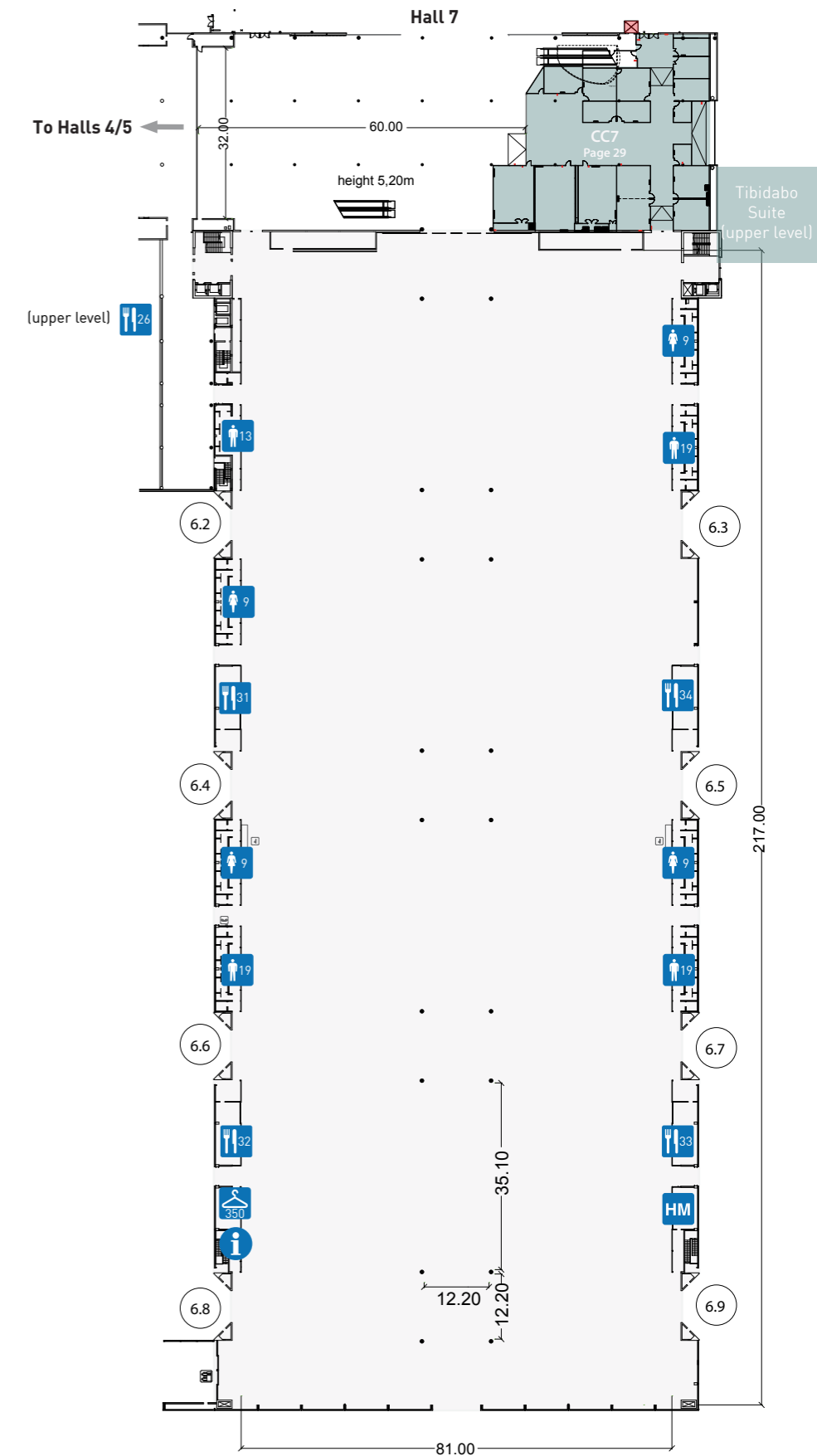

HALL 7

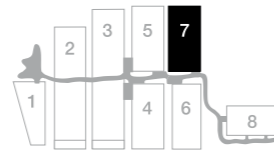

Gross Surface	17,000 m ²
Ground Resistance	3,000 kg/m ²
Height	11 m

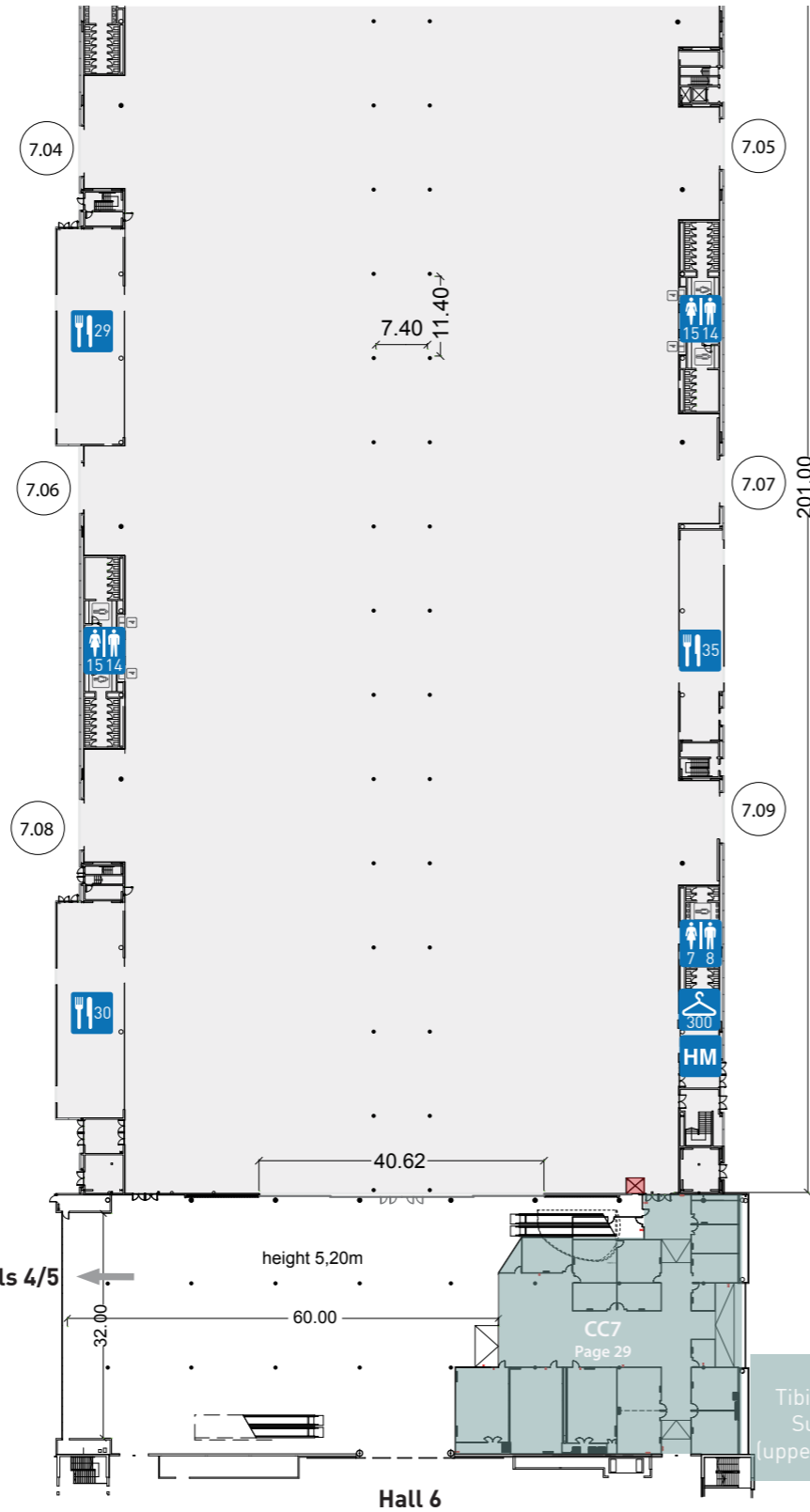

HM Hall manager

FOOD OUTLET CAPACITIES

	INDOORS	OUTDOORS
Outlet 29	100	140
Outlet 30	100	100
Outlet 35	80	140

HALL 8.0

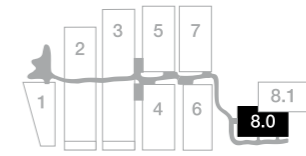

Gross Surface	13,800 m ²
Ground Resistance	3,500 kg/m ²
Height	6.70 m

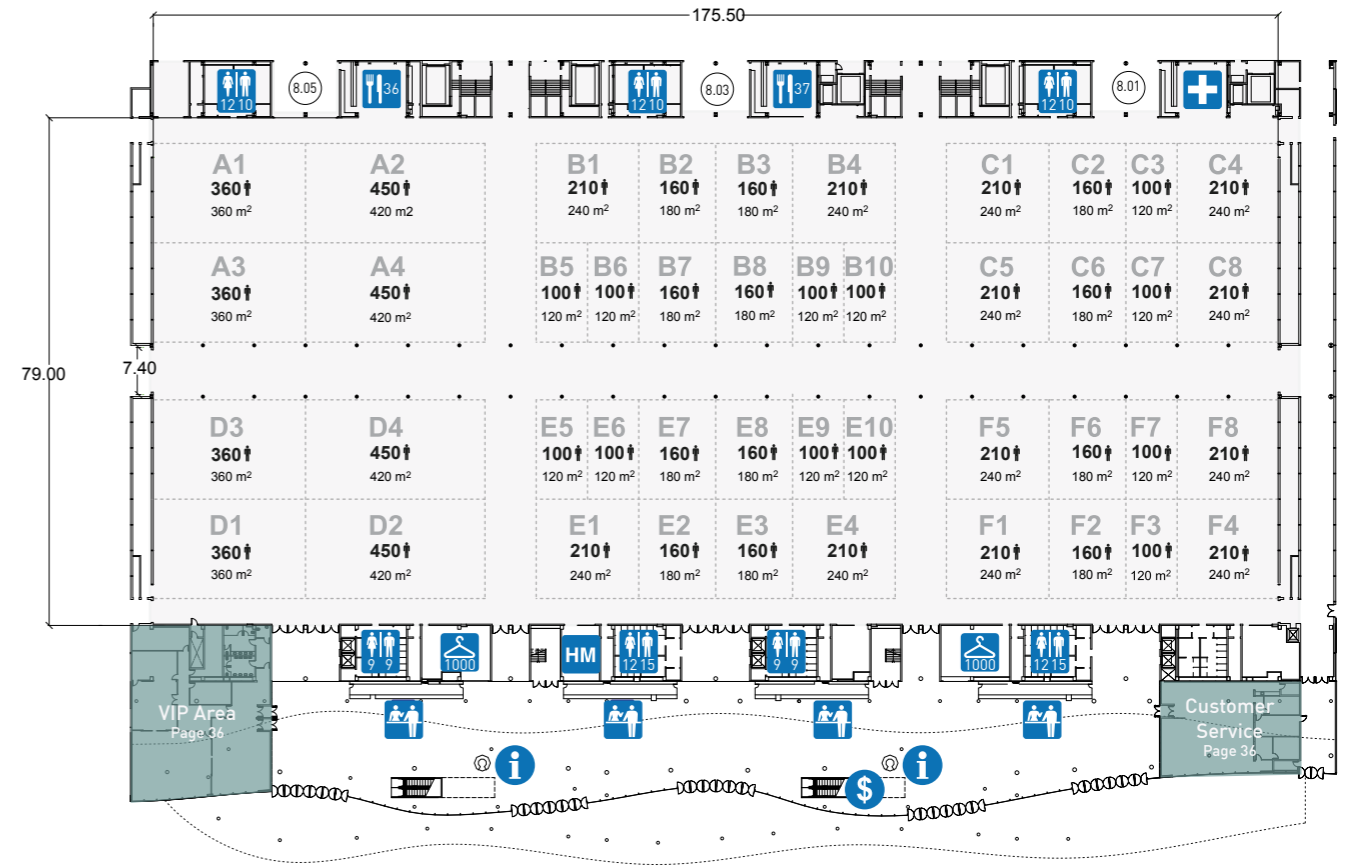

All possible divisions that can be created with the completely soundproof air wall system. Capacities of rooms differ from 2,500 to 100 seats in theatre style.

- Outlet
- Cloakroom
- WC
- Hall manager
- Info point
- ATM
- Registration counter
- First Aid

FOOD OUTLET CAPACITIES

	INDOORS	OUTDOORS
Outlet 36	50	-
Outlet 37	50	-



HALL 8.1

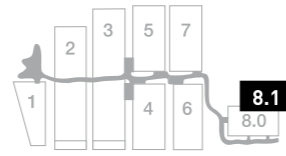

Gross Surface	12,700 m ²
Exhibition Area	10,500 m ²
Ground Resistance	1,500 kg/m ²
Height	11 m

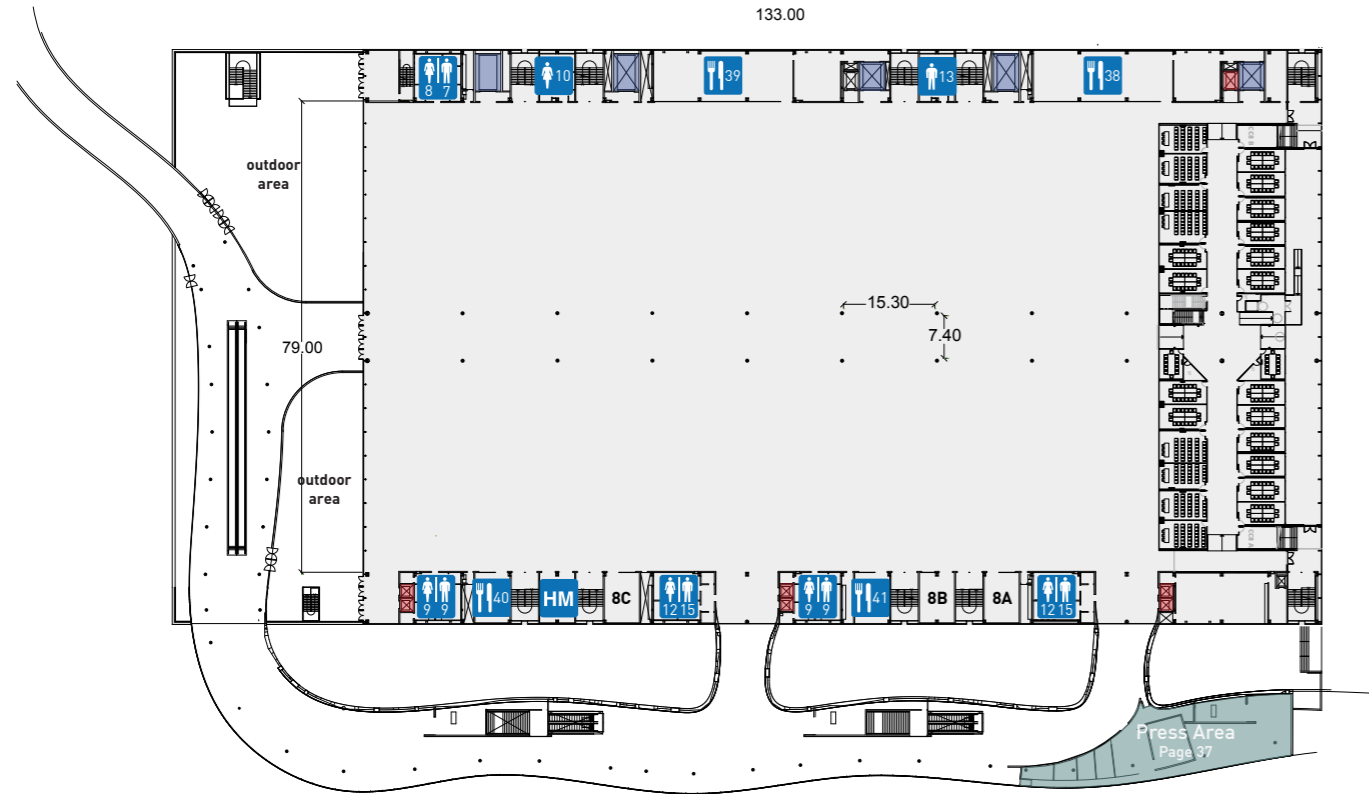

- Outlet
- WC
- Hall manager
- Goodslifts 3 units 6 ton
2 units 4 ton

FOOD OUTLET CAPACITIES

	INDOORS	OUTDOORS
Outlet 38	120	-
Outlet 39	120	-
Outlet 40	10	-
Outlet 41	10	-



SOUTH ACCESS

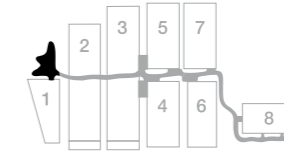

LEVEL 0

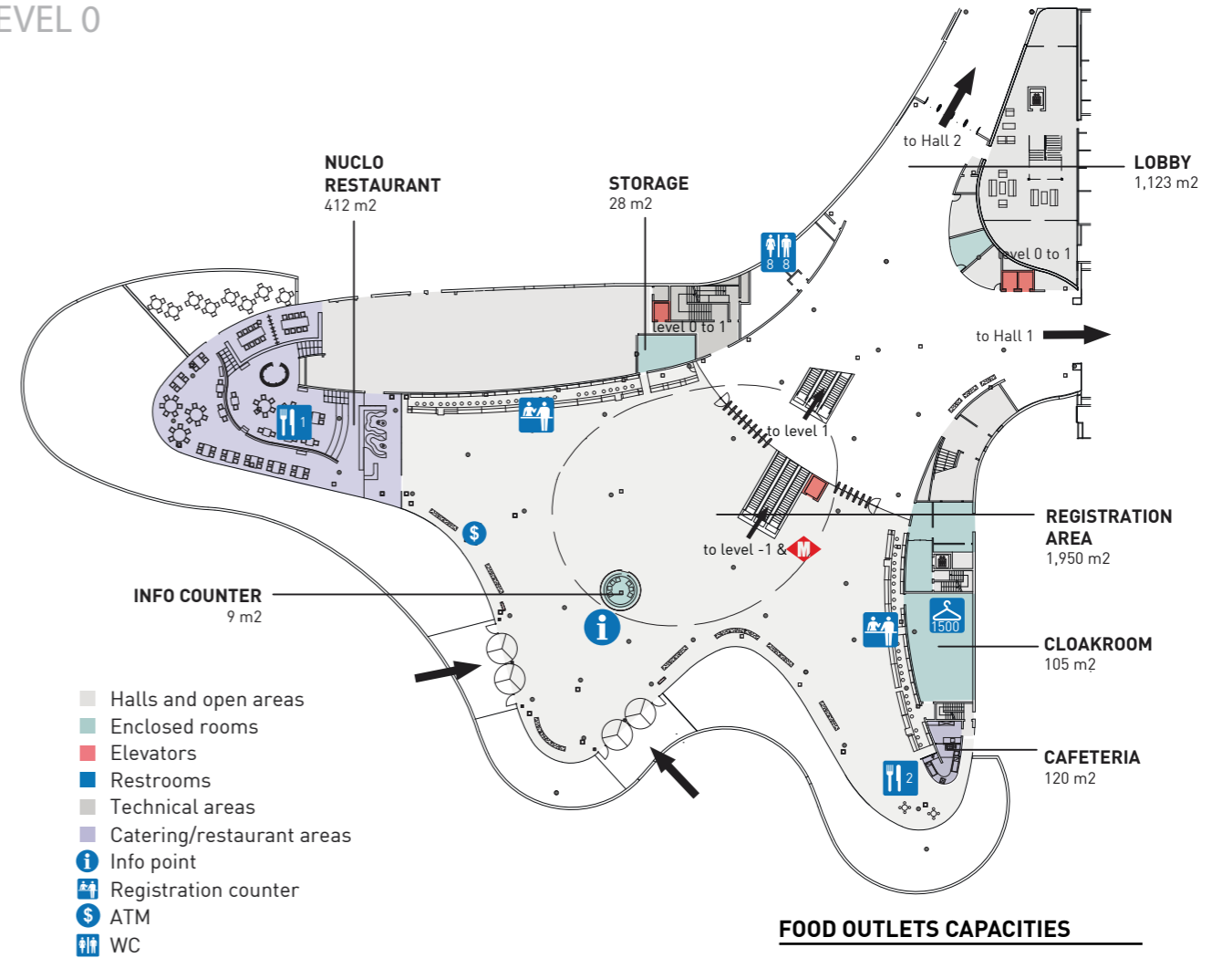

FOOD OUTLETS CAPACITIES

	INDOORS	OUTDOORS
Outlet 1 (Nuclø)	150	24
Outlet 2	50	-

LEVEL -1

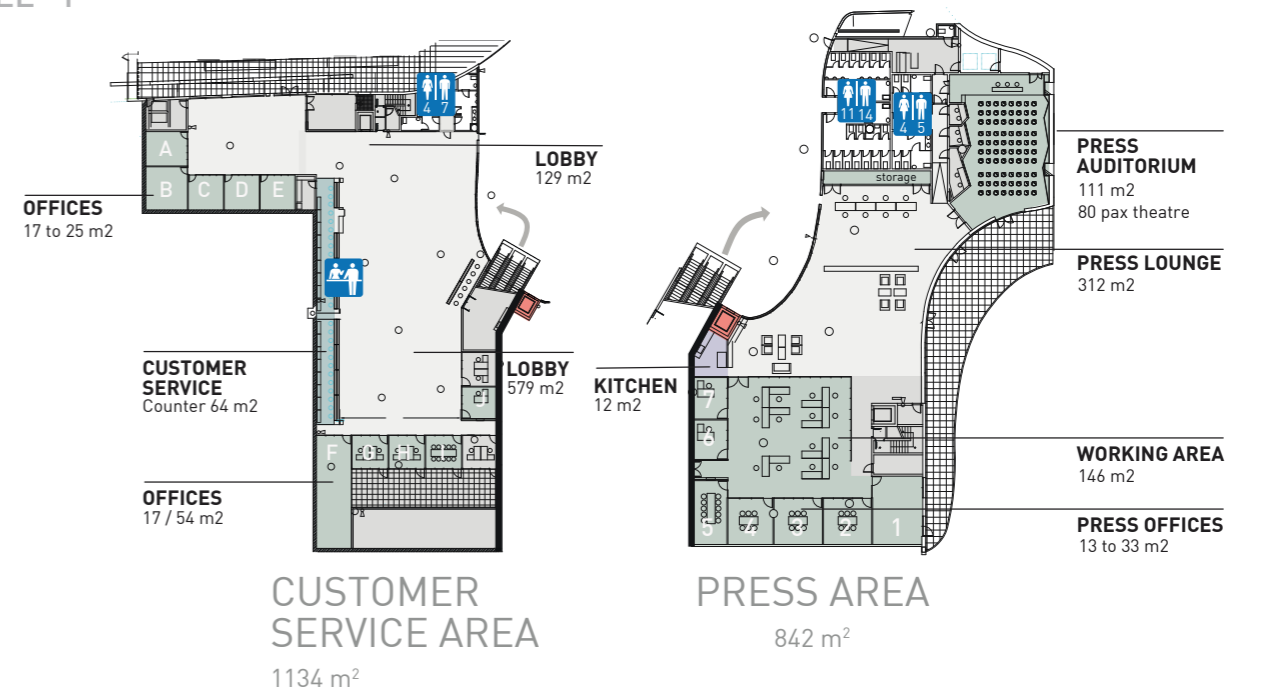

BARCELONA SUITE

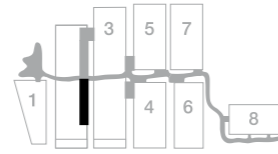

Number of Rooms	47
Room height	2.60m
Sizes	18-25 m2/ 32-36 m2
Capacities	8 pax/ 16 pax

Soundproof walls. Furnished with table, chairs and lockable cupboard. Sockets on wall: 4 units. Floor mounted electrical box with 4 sockets and ethernet connection.



18m2/ 8 pax	36 rooms
21m2/ 8 pax	3 rooms
25m2/ 8 pax	1 room
32m2/ 16 pax	1 room
36m2/ 16 pax	6 rooms

- Halls and open areas
- Enclosed rooms
- Elevators
- Restrooms
- Technical areas/ stairs

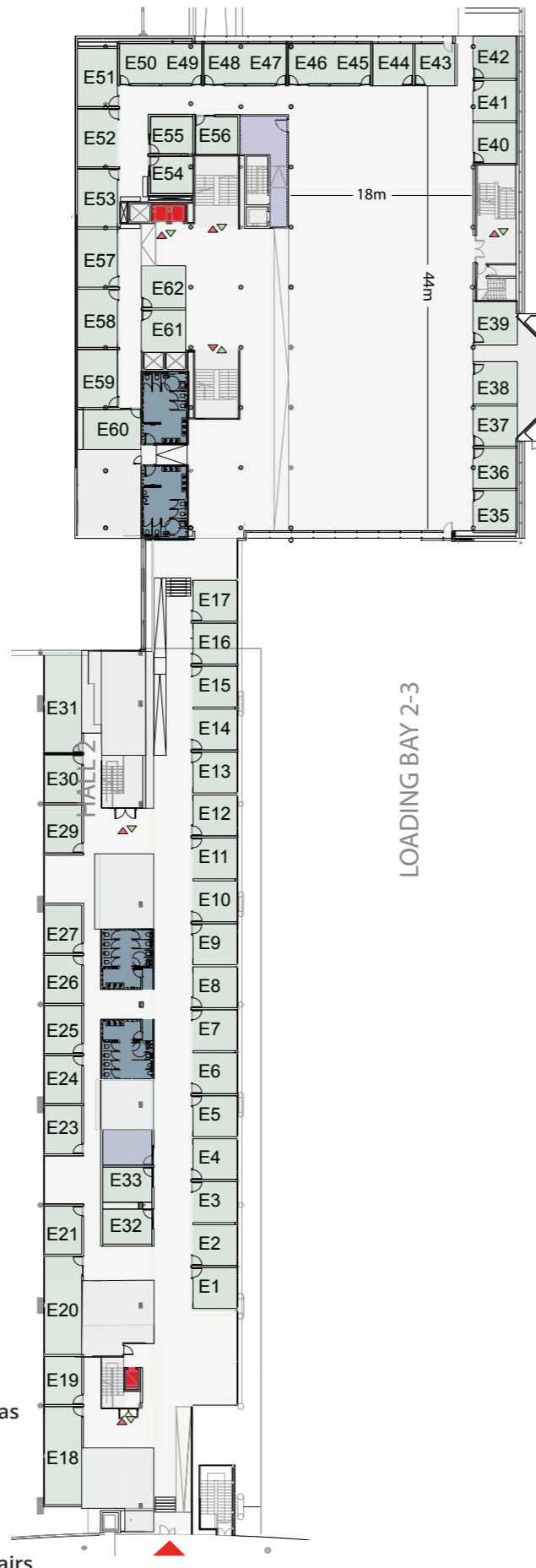

EUROPA SUITE

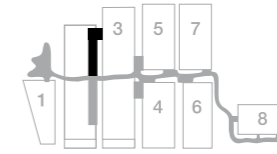

Number of Rooms	56
Room height	2.60m
Sizes	16-23 m2 / 32-36 m2
Capacities	8 pax / 16 pax

Soundproof walls. Furnished with table, chairs and lockable cupboard. Sockets on wall: 4 units. Floor mounted electrical box with 4 sockets and ethernet connection.



16m2/ 8 pax	15 rooms
18m2/ 8 pax	28 rooms
23m2/ 8 pax	7 rooms
32m2/ 16 pax	3 rooms
36m2/ 16 pax	3 rooms

- Halls and open areas
- Enclosed rooms
- Elevators
- Restrooms
- Technical areas/ stairs

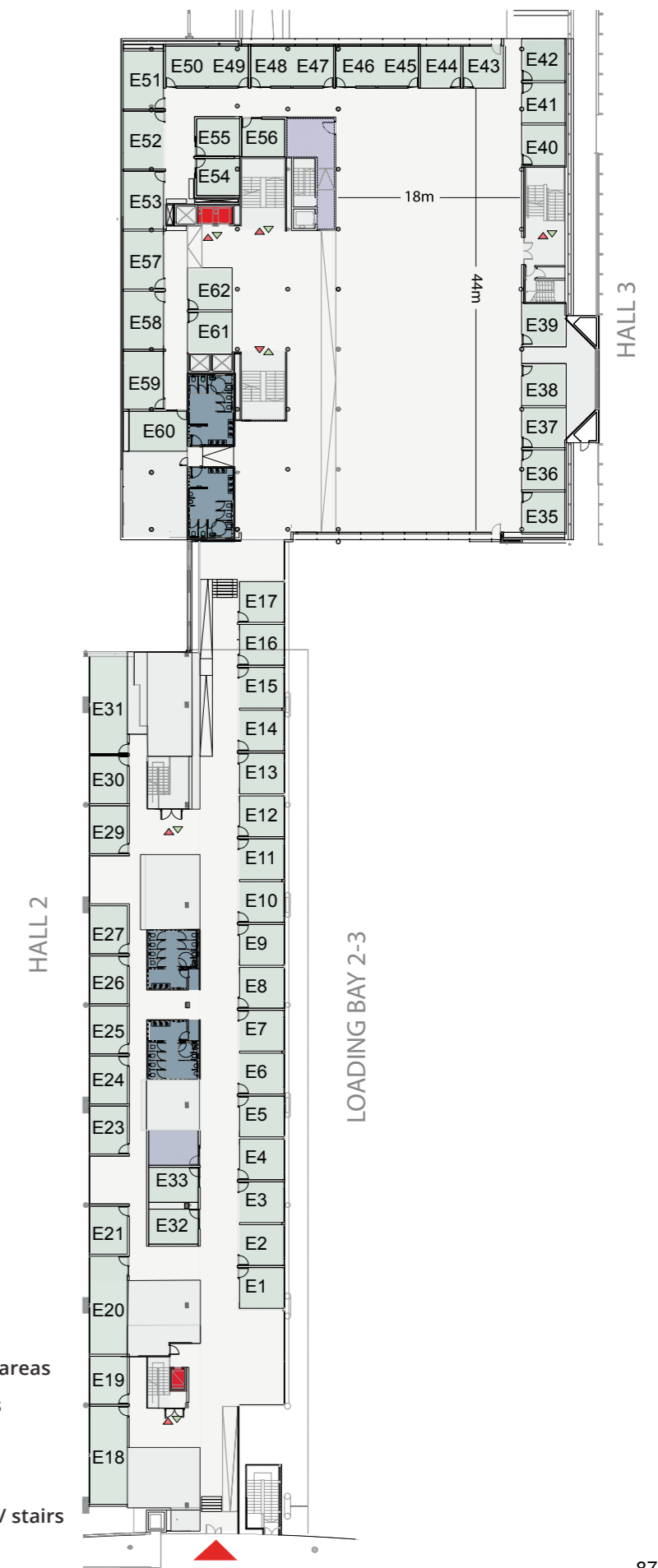

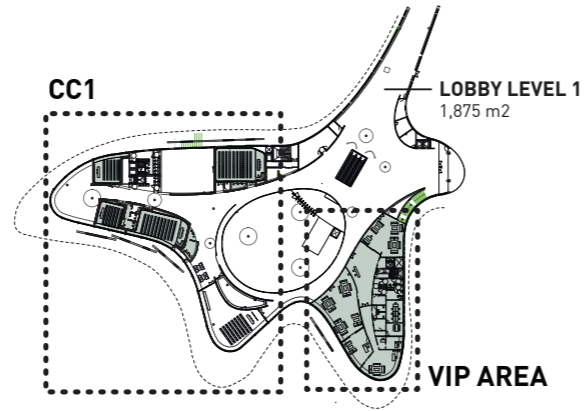

CONFERENCE CENTER 1

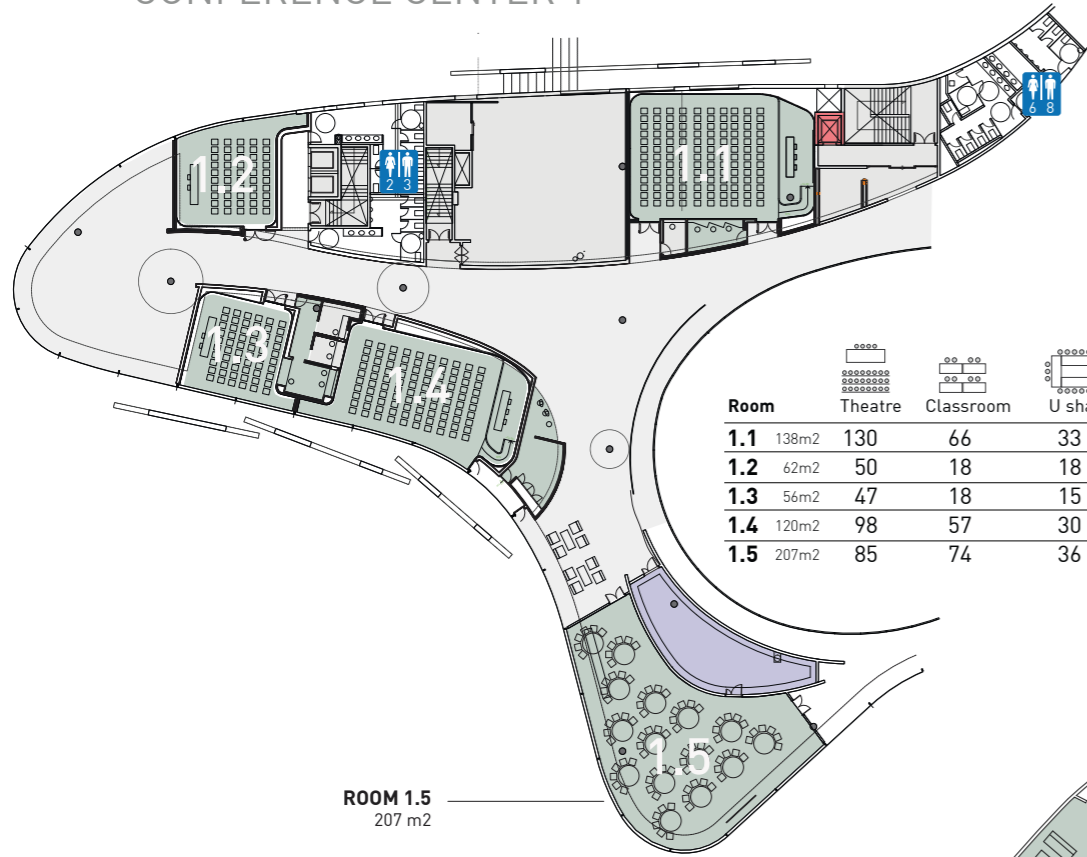

Room	Theatre	Classroom	U shape	Boardroom	Banquet	Cabaret
1.1	138m2	130	66	33	39	66
1.2	62m2	50	18	18	21	-
1.3	56m2	47	18	15	18	-
1.4	120m2	98	57	30	33	50
1.5	207m2	85	74	36	-	80

ROOM 1.5
207 m2

VIP AREA
738 m²

VIP AREA RECEPTION
106 + 32 m2

BOARDROOM
163 m2

DIRECTOR'S RECEPTION
57 m2

DIRECTOR ROOM
71 m2

VIP AREA MEETING ROOM
110 m2

BOARDROOM
32 m2

OFFICE
18 m2

OFFICE
8 + 17 m2



EAST ACCESS AND
CONFERENCE CENTER 3

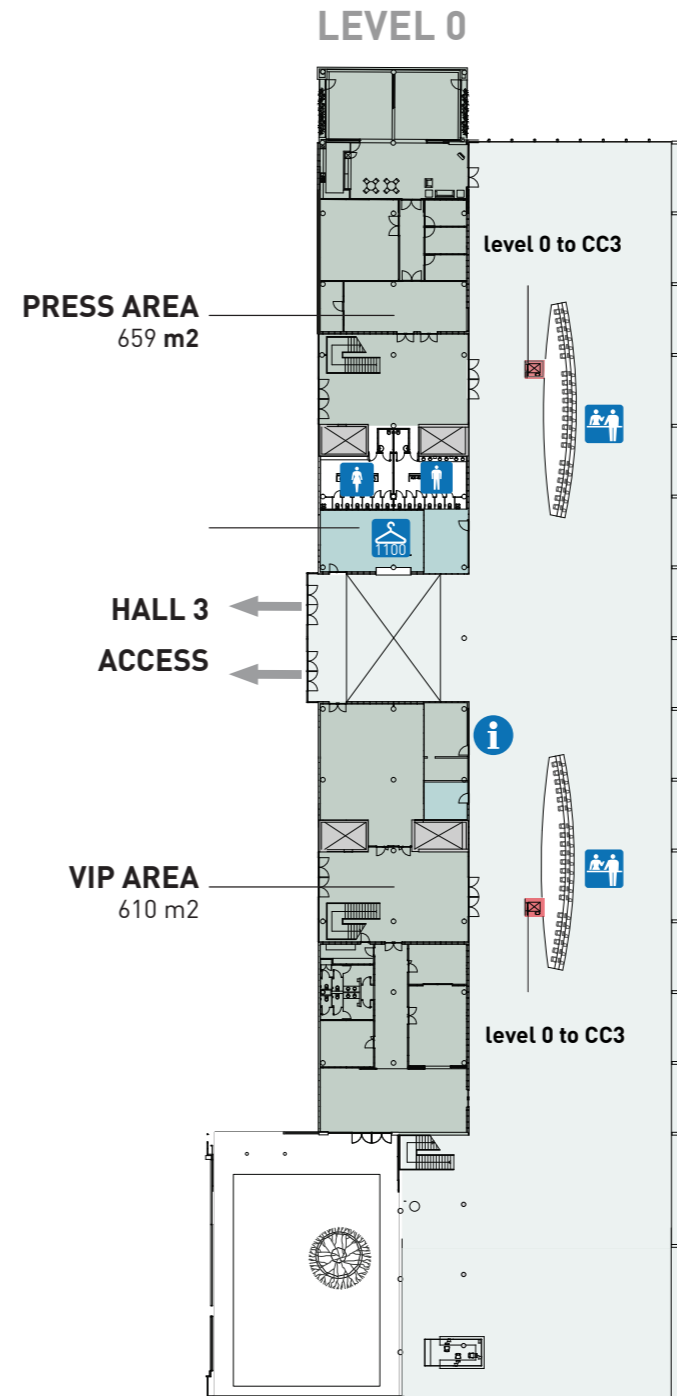
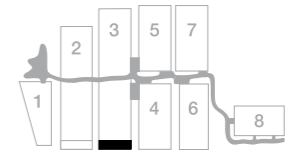

LEVEL 1

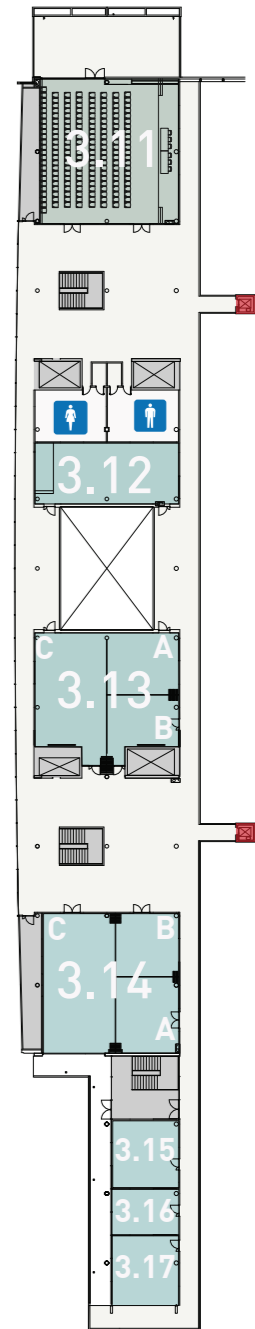

Room	Theatre	Classroom	U shape	Boardroom
3.11	182	126	42	60
3.12	88	48	36	39
3.13	150	102	42	54
3.14	152	105	42	54
3.15/3.17	12	-	-	12
3.16	12	-	-	12

CONFERENCE CENTER 4

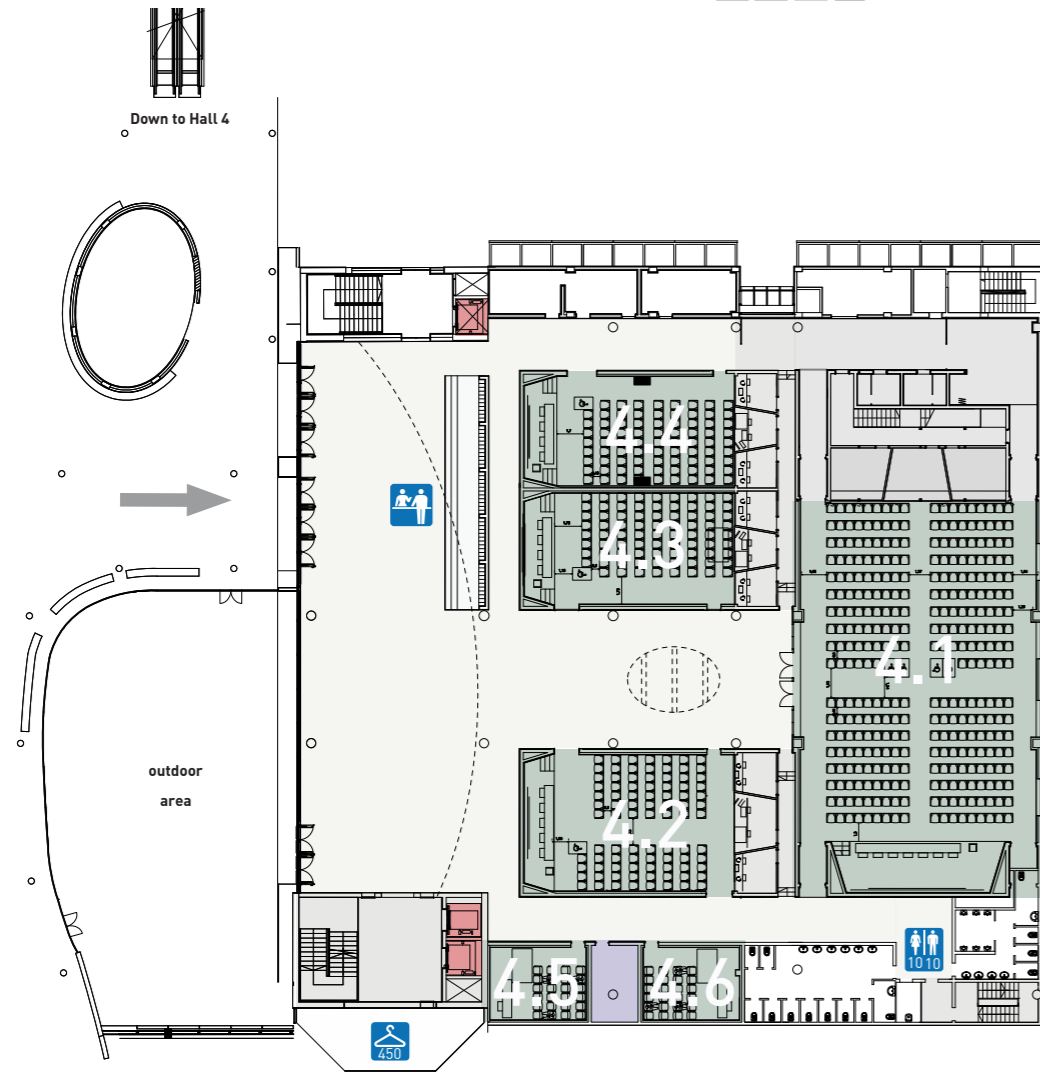
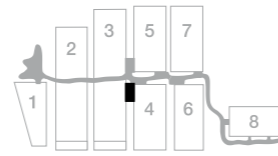

Room	Theatre	Classroom	U shape	Boardroom	Banquet	Cabaret
4.1	326	219	69	84	140	120
4.2	89	54	24	30	-	-
4.3	81	36	24	30	-	-
4.4	80 (36+36)	36	24	20	-	-
4.5/4.6	24	10	12	12	-	-

CONFERENCE CENTER 5

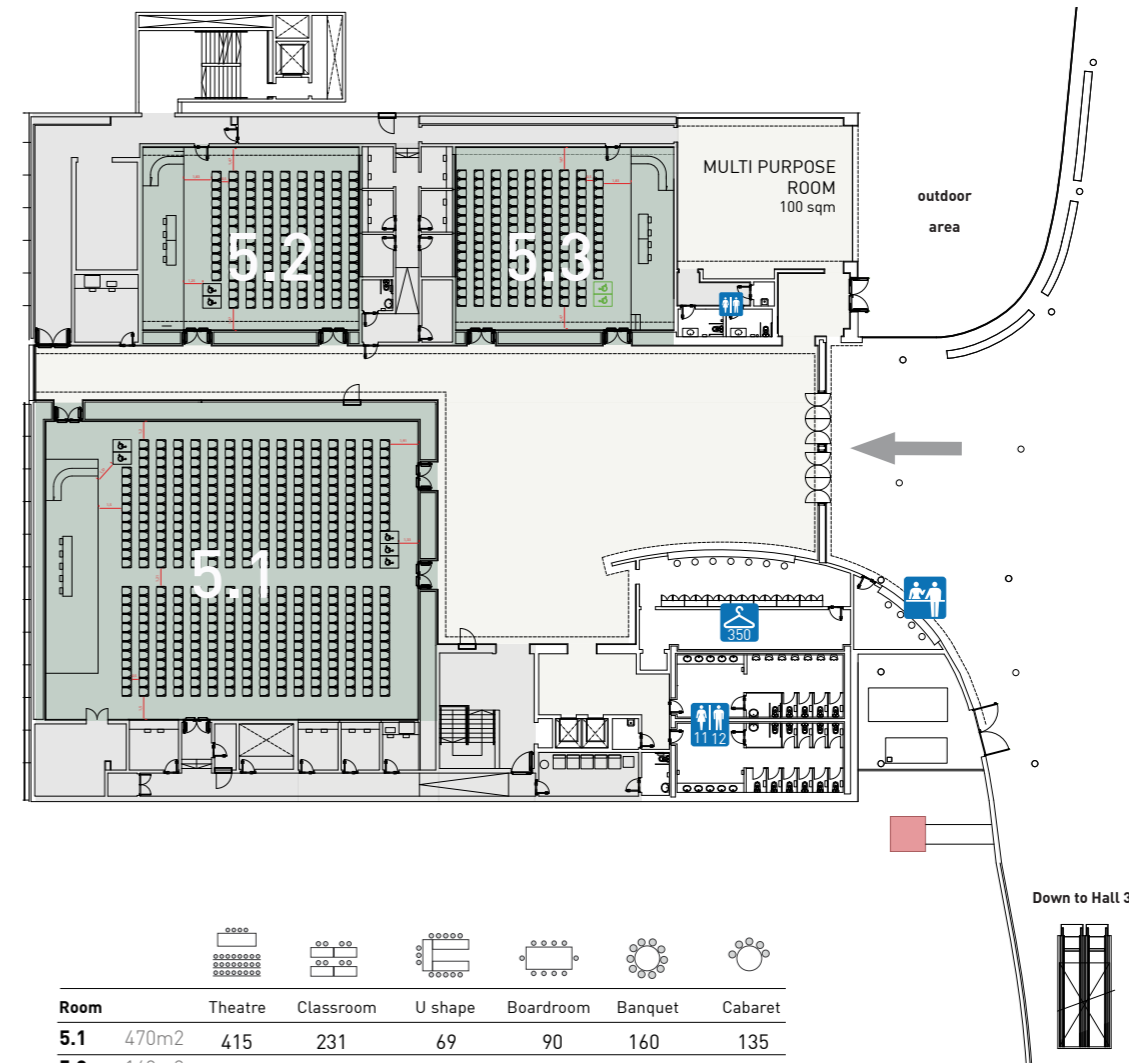
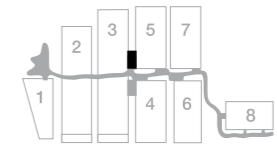

Room	Theatre	Classroom	U shape	Boardroom	Banquet	Cabaret
5.1	470m2	415	231	69	90	160
5.2	168m2	134	72	33	42	-
5.3	168m2	134	72	33	42	-



CONFERENCE CENTER 7

Room	Theatre	Classroom	U shape	Boardroom
7.1 A + B + C	253m2	222	120	63
A	81m2	77	30	21
B	91m2	80	36	27
C	81m2	74	30	21
7.2 & 7.3	37m2	20/21	12	14
7.2 + 7.3	74m2	67	36	27
7.4 & 7.5	40m2	25	12	14
7.4 + 7.5	80m2	67	36	27
7.6 & 7.7	13m2	-	-	8
7.8 & 7.9	26m2	-	-	16
7.10	21m2	-	-	14
7.11	38m2	-	-	16
7.12	24m2	-	-	14
7.13	24m2	-	-	14
7.14	38m2	-	-	16
7.15	35m2	-	-	16

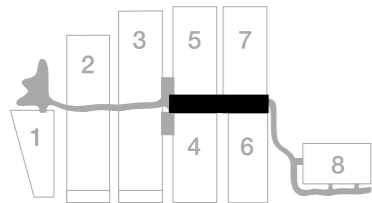
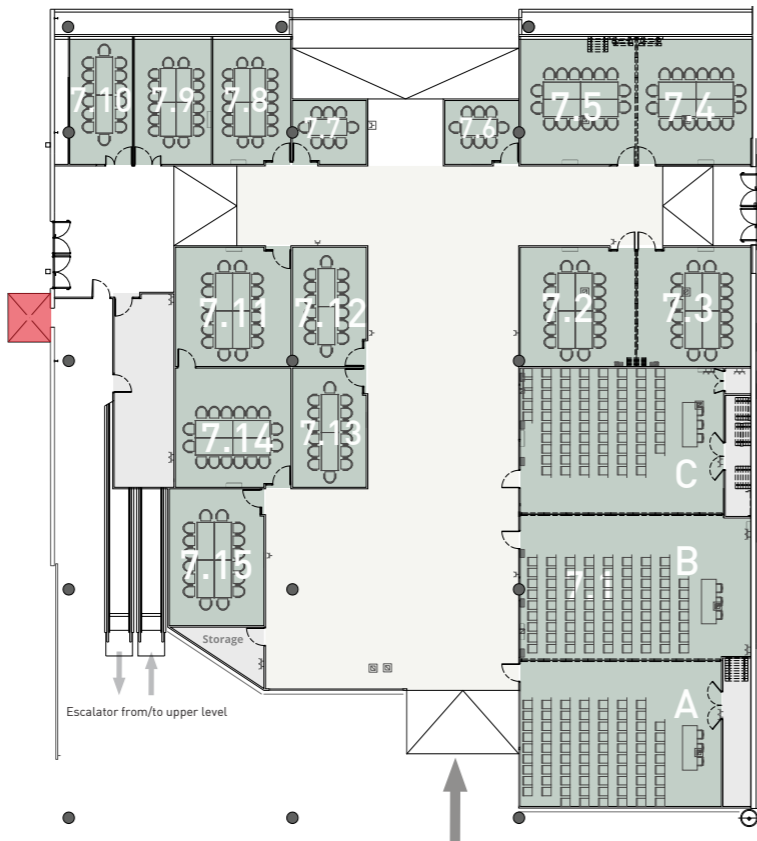

LINK HALLS 4, 5, 6 and 7

Gross Surface	7,500 m2
Ground Resistance	1,000 kg/m2
Height	5,20 m

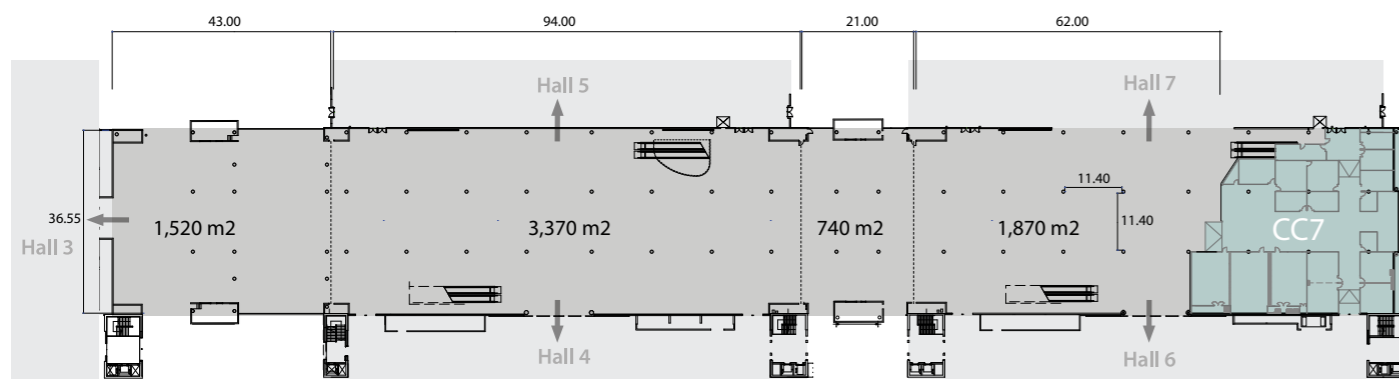

CONFERENCE CENTER 8

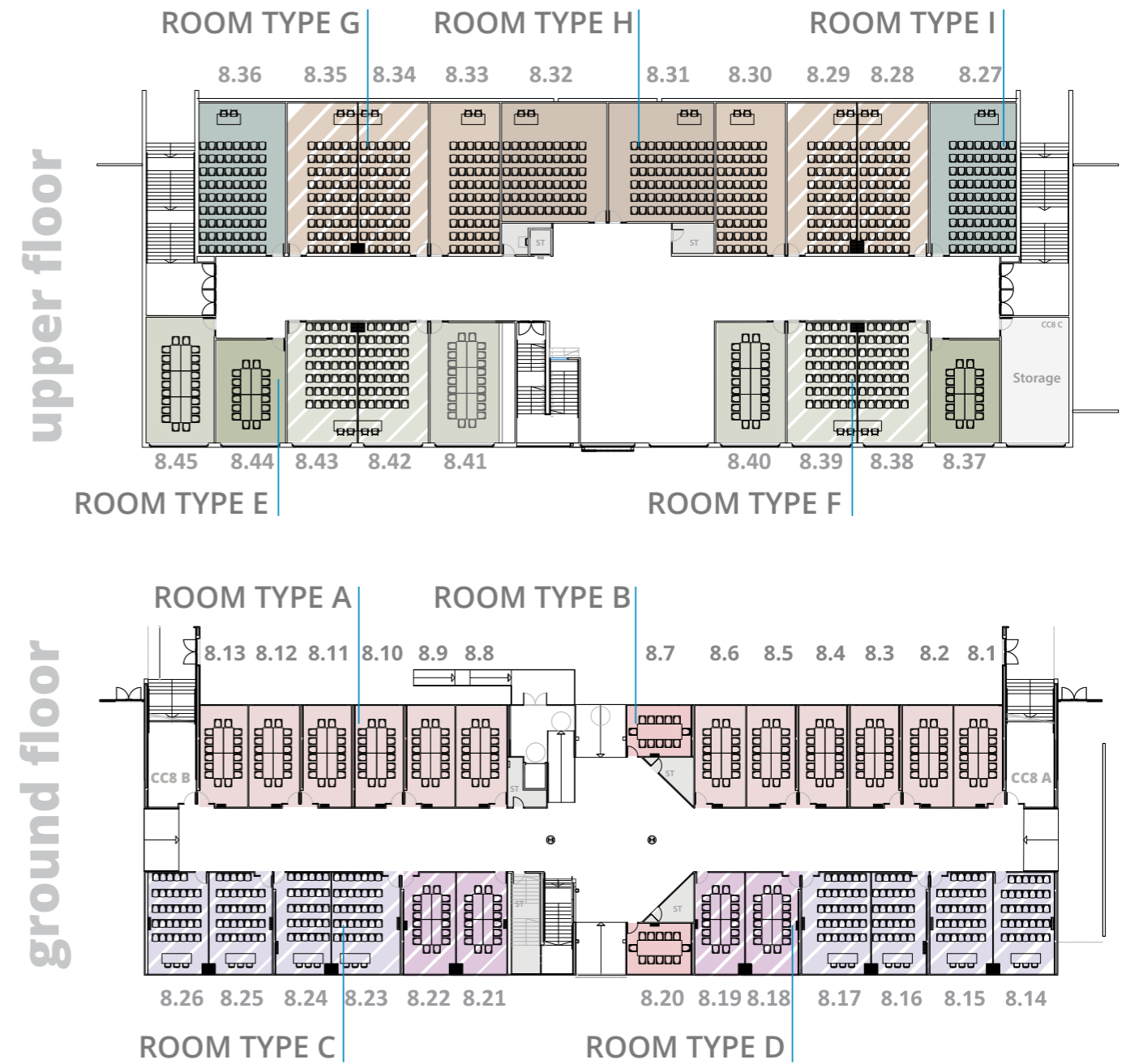
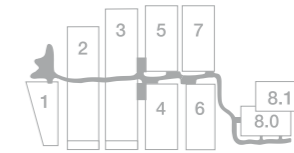

Capacities

Room			
12 X	Type A	30 m2	16 pax boardroom
2 X	Type B	20 m2	12 pax boardroom
8 X	Type C	44 m2	29 pax theatre
all 8 can be merged into 4			
4 X	Type C merged	78 m2	74 pax theatre
4 X	Type D	32 m2	29 pax theatre
all 4 can be merged into 2			
2 X	Type D merged	64 m2	57 pax theatre
2 X	Type E	42 m2	16 pax boardroom
7 X	Type F	50 m2	22 pax boardroom
4 can be merged into 2	Type F merged	100 m2	96 pax theatre
6 X	Type G	63 m2	28 pax boardroom
4 can be merged into 2	Type G merged	127 m2	124 pax theatre
2 X	Type H	75 m2	84 pax theatre
2 X	Type I	80 m2	81 pax theatre

TIBIDABO SUITE

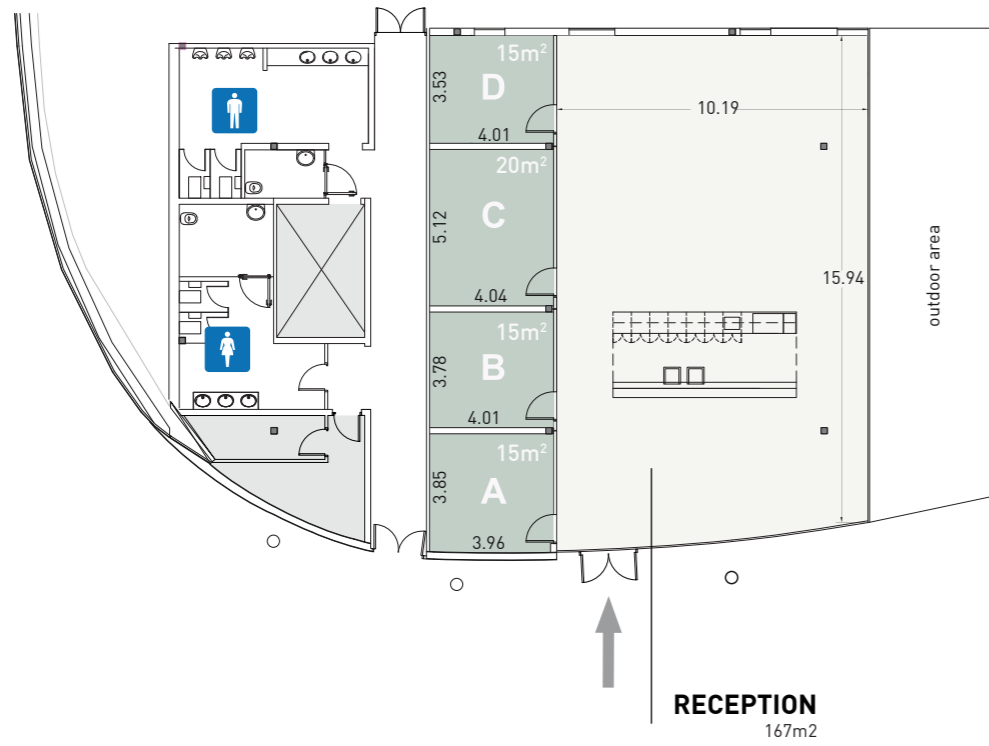
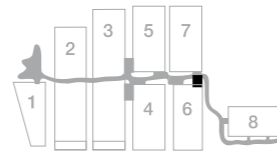

PLENARY ROOM

HALL 6

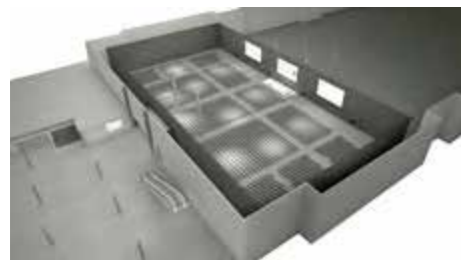

Gross Surface 3,400 sqm
 Curtain height 10 m

Permanent structure to build a temporary plenary room of 3,600 seats extendible to 5,600 seats

NORTH ACCESS

LEVEL 0

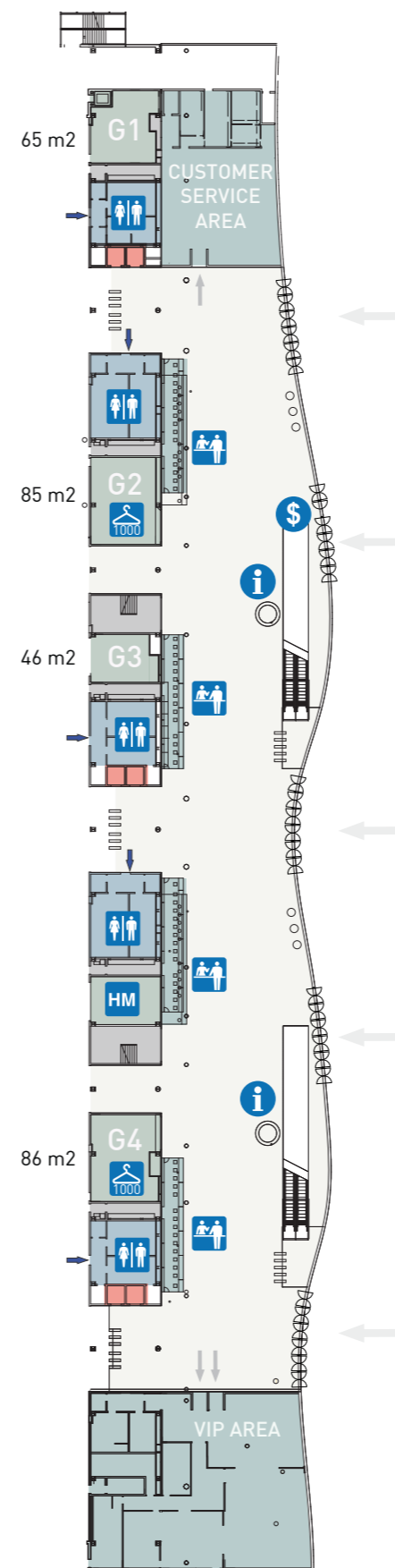
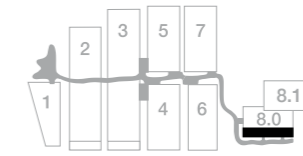

CUSTOMER SERVICE AREA

300 m²

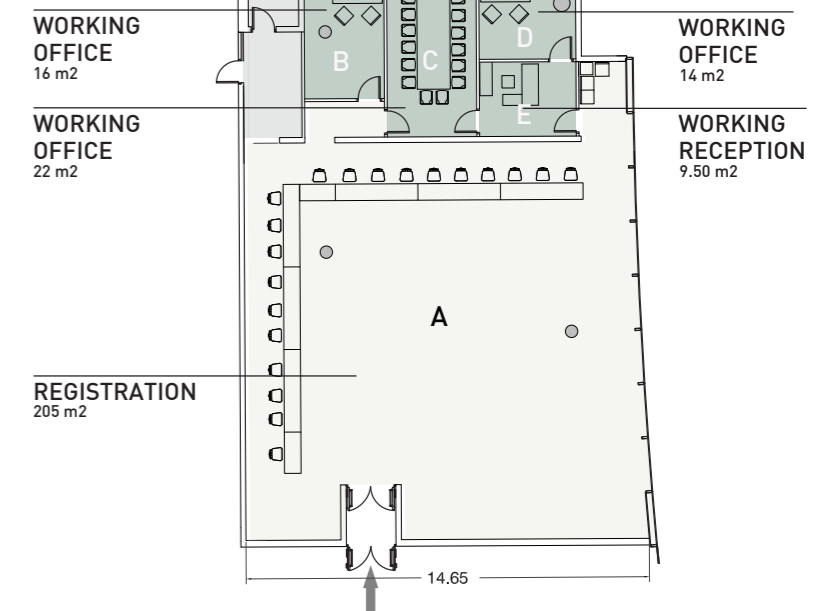

VIP AREA

440 m²

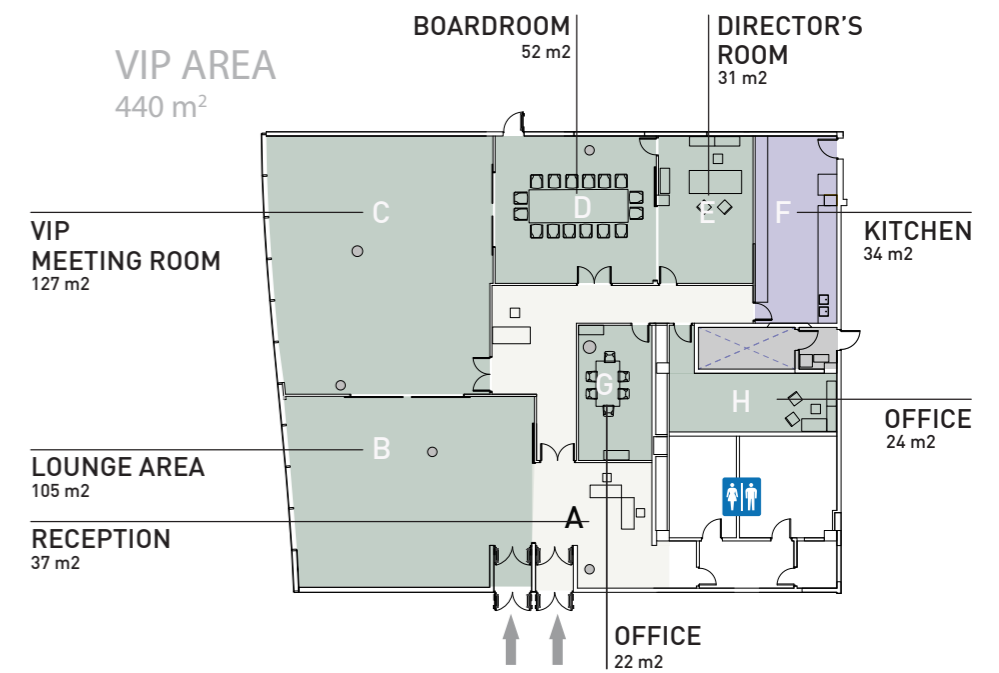

- WC
- Info point
- Registration counter
- Hall manager
- ATM

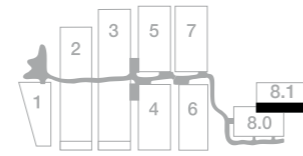

LEVEL 1

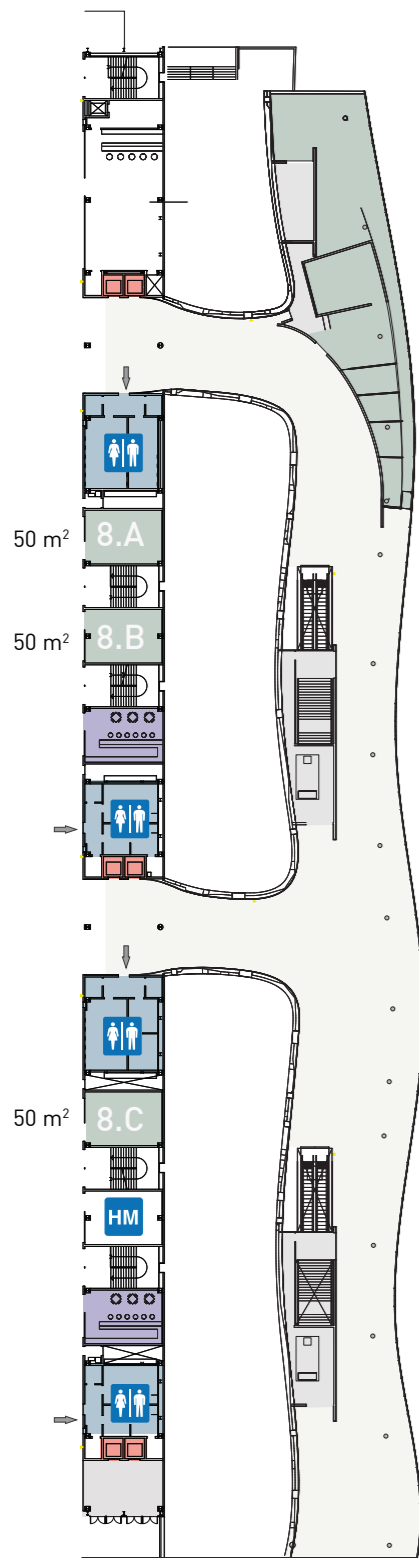

PRESS AREA
370 m²

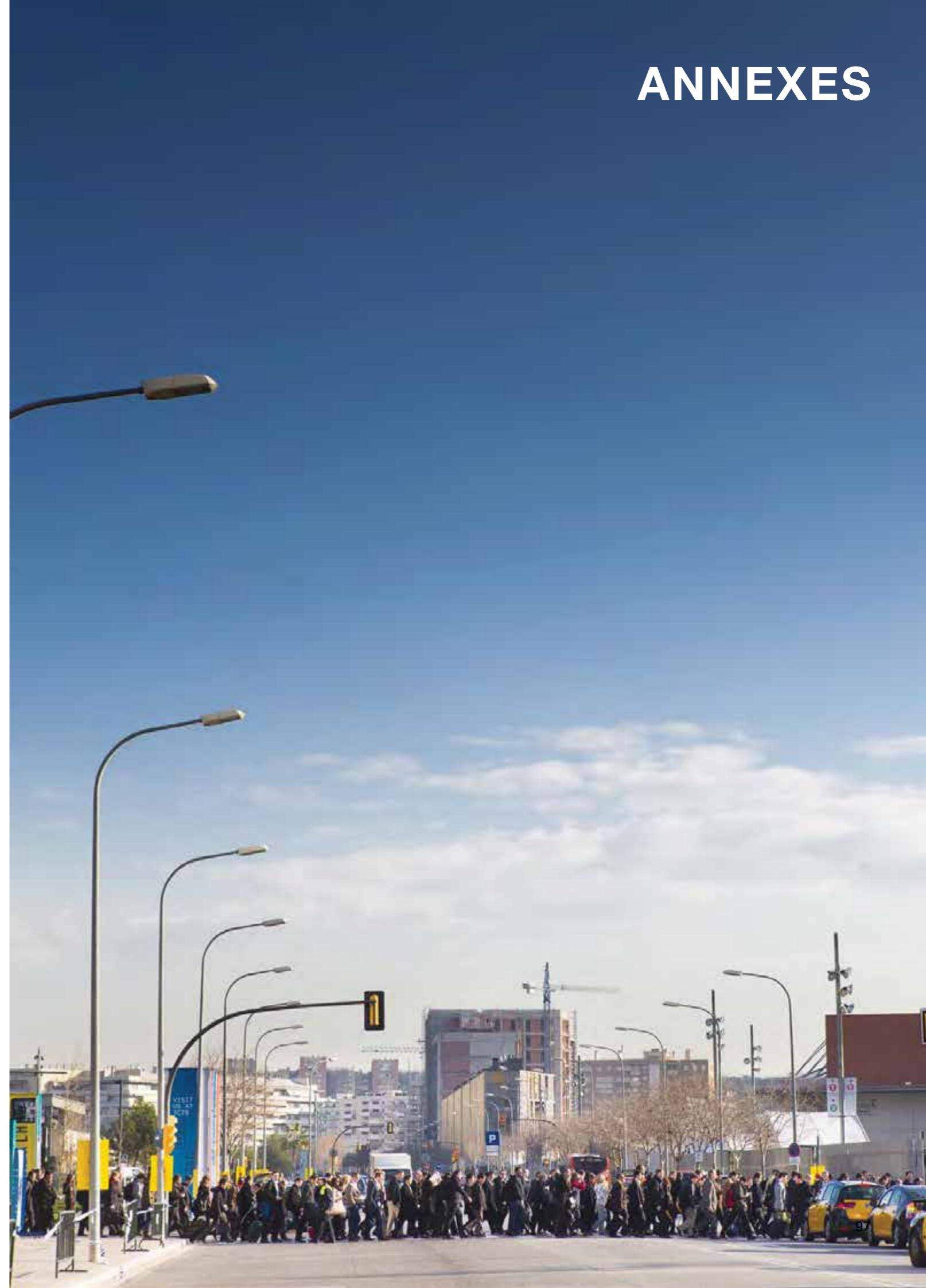
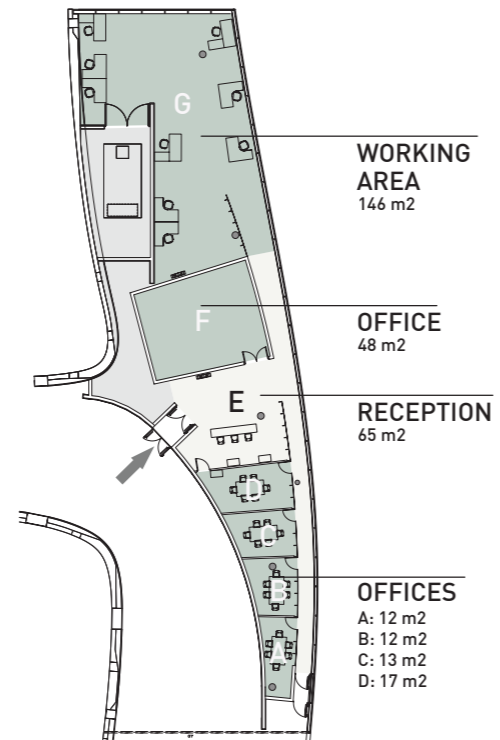

ANNEX I: MEASURES TO TAKE IN THE CASE OF EMERGENCY

WHEN ACCESSING THE HALL WHERE YOUR STAND IS LOCATED

Identify and show your employees the evacuation routes, emergency exits and fire extinguishing equipment near your stand.

WHAT TO DO IN THE CASE OF EMERGENCY

Stay calm. Avoid spreading panic.

Inform Fira de Barcelona personnel and call the Gran Via Control Center at **+34 93 233 41 00**, or use the emergency buttons.

Do not block the emergency exits.

EVACUATING THE AREA

Upon hearing the evacuation order, please inform all personnel under your responsibility and the visitors who are at your stand at that particular time. Please follow the order immediately.

Use evacuation routes to reach the emergency exits. Walk, do not run. Follow the instructions given over the public address system and by uniformed emergency personnel.

Do not use the elevators.

Remain at the meeting point indicated by the security personnel and await instructions. If you see that someone is missing, inform the emergency teams.

WE NEED YOUR COOPERATION

Immediately inform our Security Department (either the uniformed guards or by calling **+34 93 233 41 00**) of any object, situation, or incident which in your opinion might have serious security implications.

ANNEX II: OCCUPATIONAL RISK PREVENTION. RISKS AND PREVENTATIVE MEASURES

There must be a safety report available to exhibitors and decorators that includes the description of the work to be carried out, the assessment of the risks and the preventative measures of the activity, as well as a nominal list of the employees who participate, confirming that they have received:

Information on risks and preventative measures provided by Fira de Barcelona.

Specific training on Occupational Risk Prevention.

They must also have verification of the competency of employees with regard to Health Monitoring and provide their employees with personal protective equipment, the use of which is required during the build up/break down work.

In all cases, the material that they use must always be in accordance with the current legislation on occupational risk prevention and the current regulations of the Ministry of Industry.

Exhibitors and companies hired by those involved in the build up and break down of stands must immediately report any accident or incident that occurs during the work to Fira de Barcelona.

Information on risks and preventative measures to be adopted during the build up and break down

Risks

People falling to a different level, due to use of stairs and scaffolding.

People falling to the same level, due to objects in aisles.

Falling objects from heights, arising from the installation of stands, suspended loads, etc.

Knocks against immobile objects.

Stepping on objects, such as boards, wood, nails, etc. arising from the build up and break down.

The projection of fragments or particles arising from build up and break down work.

Cuts or blows from objects and/or tools.

Electrical contacts arising from work with electrical tools and the installation of lighting.

Fire and explosion.

Exposure to noise due to the use of manual tools or machine tools.

Knock-downs by vehicles in motion in the entire venue.

Preventive Measures

Operators working at height shall be provided with sufficient safety material to prevent the risk of falling (safety harnesses, ladders, scaffolding, etc.).

Ladders must have non-slip feet, anti-opening mechanisms and be in a good state.

The correct use of manual ladders.

Scaffolding must bear the CE marking and be correctly mounted (with platforms at least 60 cm wide and handrails at 90 cm height, with an intermediate bar and kick plate).

Offices and workplaces must always be in a good state of cleanliness, hygiene and free from waste materials.

Fire extinguishing equipment and emergency exits must always remain visible and free from obstructions.

All chemical products must be clearly labeled, to ensure the identification of the substance (paints, solvents, oils, degreasers, etc.).

The entry of inflammable products is not permitted.

A special work permit is required to carry out welding. Welding equipment shall not be used without Fira's prior authorization.

In electric welding work, all equipment used shall be in a safe condition: equipment protection, wire insulation with no splits and proper connections.

All load lifting equipment, cranes, forklift trucks, etc., must have all relevant safety elements and be in line with current regulations.

This work equipment may only be operated by authorized, qualified personnel who are responsible for their actions.

Suspended loads shall not be moved above people.

The maximum speed limit in the Fira de Barcelona venue will be 10 kph.

For work with electrical equipment, protection, plugs, wires, fuses, earthing, etc., must be in a good condition.

Electrical work may only be carried out by qualified personnel. The manipulation of the electrical installations is strictly forbidden.

Discs and saw and carpentry cutting elements must be protected.

The use of safety footwear, gloves protecting against mechanical hazards and protective glasses is compulsory.

The use of a safety helmet will be required in work that requires it (risk of falling objects, double decker stands, blows from suspended objects, etc.).

Use reflective vests when vehicles are moving and in outdoor work.

Information on risks and preventative measures to be adopted during show days

Risks

People falling to a different level. People falling down stairs of double decker stands. Falls from using the wrong furniture or not using stepladders.

People falling to the same level. Tripping over stand platforms. Tripping due to untidy or non-cleaned areas. Slipping on slippery surfaces.

Dropping objects during handling. Manual handling of office material, filing cabinets, advertising brochures, etc.

Knocks or cuts from immobile objects. Knocks against lamps and furniture. Knocks against exhibition material.

Blows or cuts from objects and/or tools. Cuts from office tools: scissors, cutters, etc.

Overexertion. Handling and transportation of exhibition material. Handling packages with informative brochures.

Contact with heat. Burns from spotlights, halogen lamps.

Contact with electrical elements. Equipment with plugs or cables in a poor condition. Open electrical switchboards. Situations of conflict generated by the work or occupational environment.

Risks caused through ergonomic or postural deficiencies. Inadequate furniture. Muscle or joint pain from using laptops.

Risks derived from exhibition material or machinery.

Preventative measures

Ensure that fixed staircases have handrails or banisters.

Have stepladders available and check that they are in an acceptable condition before using them.

Signpost irregularities in floor levels.

Ensure the area is clean and tidy.

Signpost wet areas after cleaning.

Use properly fitting shoes.

Training and information on the manual handling of loads.

Signposts in the case of any obstructions to aisles.

Keep everything clean and tidy.

Training and information on the proper use of office tools.

Training and information on the manual handling of loads.

Protect contact zones.

Do not use equipment in a poor condition: remove it.

Keep electrical switchboards closed. Do not handle them.

Give employees instructions for action.

Have ergonomic furniture available.

Provide training and information on ergonomic postures.

The exhibitor should take the necessary preventative measures to avoid risks deriving from the material or machinery displayed in their stand.

**ANNEX III: DOCUMENT OF COMMITMENT TO COMPLY WITH THE CURRENT LAW ON FOOD HYGIENE
(REGULATION 852/2004)**

COMPANY AND CONTACT	LOCATION
Company: _____	Venue: Montjuïc: _____ Gran Via: _____
Contact: _____	Hall/ Area/ Stand Number: _____
Tel.: _____	
E-mail: _____	

Mark the following, as appropriate

SALE: GIFT:
REFERENCES FORMAT RRP

The company
Indicate company Origin Products and General Sanitary Record Number (if applicable):

Other company (catering, food company)*
*Indicate Company Name: _____
General Sanitary Record Number (in the case of catering): _____
Contact Person _____ Tel.: _____
The products will be served by:

Commitment to comply with legislation:

I _____ with Foreign ID/National ID/Passport No. _____ representing the company mentioned at the beginning, attest that the provided data is correct, and I hereby undertake to ensure that the company that I represent shall comply with all current regulations on food safety (R.D. 3484/2000, Regulation 852/2004) for all services and activities offered at Fira de Barcelona.

Date: _____
Signature: _____
Company stamp: _____

Institutional information
www.firabarcelona.com

Floorplans and pictures
guestevents.firabarcelona.com/enclosure/granvia/



www.firabarcelona.com
Avda Reina Maria Cristina s/n 08004
Barcelona



Fira Barcelona